

FUI **FITTINGS** **UNLIMITED** INC

Adapter & Fitting Specialist

www.myfui.com

Standard Parts List

CORPORATE SALES

DALLAS, TX

3000 AVENUE F

ARLINGTON, TX 76011

(800) 348-8467 (281) 500-9570 FAX

CLEVELAND, OH

(800) 348-8467 (817) 860-8517 FAX

HOUSTON, TX

(800) 633-5340 (281) 500-9570 FAX

SALT LAKE CITY, UT

(800) 348-8467 (817) 860-8517 FAX

CANADA -AURORA, ONTARIO

(877) 644-4403 (905) 713-3927 FAX

ATLANTA, GA

(800) 348-8467 (817) 860-8517 FAX

TERMS - All invoices are 2%-10 Net 30 with approved credit. A 1½% finance charge will be assessed on all past due accounts. All accounts due and payable in Arlington, Tarrant County, Texas.

MINIMUM ORDER - \$25.00 per order

POR - Price On Request

RETURNS - Fittings may be returned only with authorization from FITTINGS UNLIMITED, INC. - subject to our inspection and must be shipped freight prepaid within 30 days of original shipment. A restocking fee of 20% or \$10.00, whichever is greater, will apply. In case of shipping errors, notification must be made within 30 days to receive an adjustment. Special fittings and made to order items are non-cancelable and not returnable without written consent of FITTINGS UNLIMITED, INC.

*Composite
Push Connect*

Features:

- Convenient One touch fittings provide instant tubing connections.
- Elliptical release ring facilitates pneumatic installations in confined spaces. Light manual pressure on the elliptical release ring is all that is required to instantly disconnect each tube. No special tools required.
- Nickel-plated brass threaded bodies ensures anti-corrosion and anti-contamination.
- All NPT & BSPT thread are pre-coated with sealant and require no additional sealing.
- Most all models available in inch and metric size.

Specifications:

Fluid Type	Air (No other type of gas or liquid)	
Working Pressure Range	0~150PSI	0~9.9KgF/cm2(0~990KPa)
Negative Pressure	-29.5 in Hg	-750mm Hg(10 Torr)<8
Working Temperature	32~140 degree F	0-60 degree C
Recommended tube material	Nylon and Polyurethane	

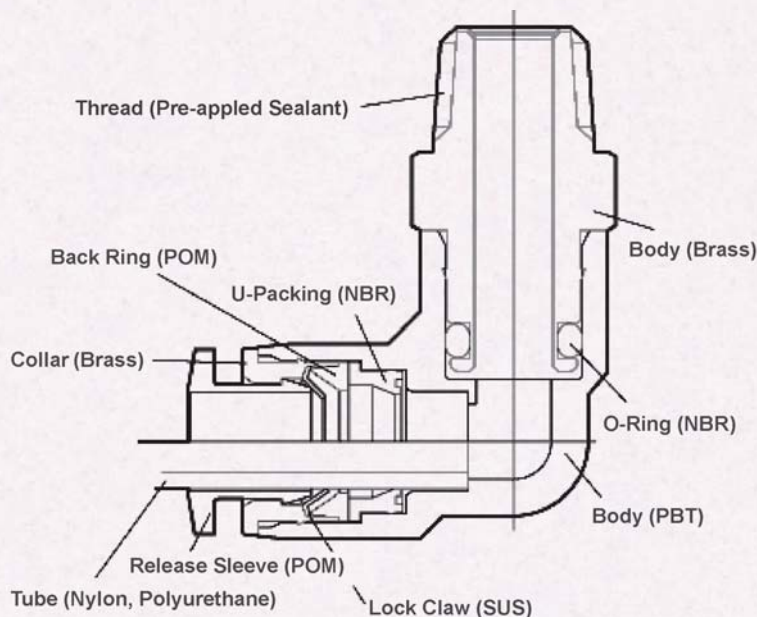

COMPOSITE PUSH CONNECT

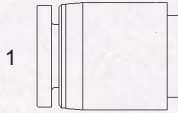

CPC-0304-C - Cap
(1) Tube Cap

CPC-0304-C-03
CPC-0304-C-04
CPC-0304-C-05
CPC-0304-C-06
CPC-0304-C-08
CPC-0304-C-5/32

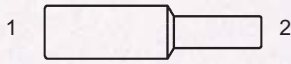

CPC-2323 - Str.
(1) (2) Plug-In Union

CPC-2323-03-03
CPC-2323-03-5/32
CPC-2323-04-03
CPC-2323-04-04
CPC-2323-04-5/32
CPC-2323-05-04
CPC-2323-05-05
CPC-2323-06-04
CPC-2323-06-05
CPC-2323-06-06
CPC-2323-08-06
CPC-2323-08-08
CPC-2323-5/32-5/32

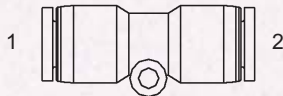

CPC-2403 - Str.
(1) (2) Tube Union

CPC-2403-02-02
CPC-2403-03-03
CPC-2403-04-02
CPC-2403-04-04
CPC-2403-04-5/32
CPC-2403-05-04
CPC-2403-05-05
CPC-2403-06-04
CPC-2403-06-06
CPC-2403-08-08
CPC-2403-5/32-02
CPC-2403-5/32-5/32

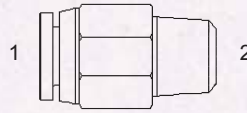

CPC-2404 - Str.
(1) Tube
(2) Male Pipe

CPC-2404-02-01
CPC-2404-02-02
CPC-2404-02-04
CPC-2404-02-10/32
CPC-2404-03-02
CPC-2404-03-04
CPC-2404-03-06
CPC-2404-03-10/32
CPC-2404-04-01
CPC-2404-04-02
CPC-2404-04-04
CPC-2404-04-06
CPC-2404-04-10/32
CPC-2404-05-02
CPC-2404-05-04
CPC-2404-05-06
CPC-2404-06-02
CPC-2404-06-04
CPC-2404-06-06
CPC-2404-06-08
CPC-2404-08-04
CPC-2404-08-06
CPC-2404-08-08
CPC-2404-5/32-01
CPC-2404-5/32-02
CPC-2404-5/32-04
CPC-2404-5/32-10/32

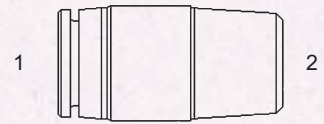

CPC-2404-NH - Str.
No Hex (Round)
(1) Tube
(2) Male Pipe

CPC-2404-NH-02-01
CPC-2404-NH-02-02
CPC-2404-NH-02-10/32
CPC-2404-NH-03-02
CPC-2404-NH-03-04
CPC-2404-NH-03-10/32
CPC-2404-NH-04-02
CPC-2404-NH-04-04
CPC-2404-NH-04-10/32
CPC-2404-NH-05-02
CPC-2404-NH-05-04
CPC-2404-NH-05-06
CPC-2404-NH-06-04
CPC-2404-NH-06-06
CPC-2404-NH-06-08
CPC-2404-NH-08-04
CPC-2404-NH-08-06
CPC-2404-NH-08-08
CPC-2404-NH-5/32-01
CPC-2404-NH-5/32-02
CPC-2404-NH-5/32-10/32

COMPOSITE PUSH CONNECT

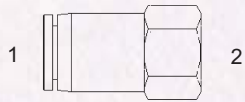

CPC-2405 - Str.

- (1) Tube
- (2) Fem. Pipe

CPC-2405-02-01
 CPC-2405-02-02
 CPC-2405-02-04
 CPC-2405-02-10/32
 CPC-2405-03-02
 CPC-2405-03-04
 CPC-2405-04-02
 CPC-2405-04-04
 CPC-2405-05-02
 CPC-2405-05-04
 CPC-2405-05-06
 CPC-2405-06-02
 CPC-2405-06-04
 CPC-2405-06-06
 CPC-2405-08-04
 CPC-2405-08-06
 CPC-2405-08-08
 CPC-2405-5/32-01
 CPC-2405-5/32-02
 CPC-2405-5/32-04
 CPC-2405-5/32-10/32



CPC-2406 - Str.

- (1) Tube
- (2) Plug-In

CPC-2406-02-04
 CPC-2406-02-5/32
 CPC-2406-04-05
 CPC-2406-04-06
 CPC-2406-04-08
 CPC-2406-05-06
 CPC-2406-05-08
 CPC-2406-06-08
 CPC-2406-5/32-04
 CPC-2406-5/32-05
 CPC-2406-5/32-06

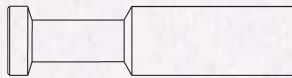

CPC-2408 - Str.

- (1) Tube Plug

CPC-2408-02
 CPC-2408-03
 CPC-2408-04
 CPC-2408-05
 CPC-2408-06
 CPC-2408-08
 CPC-2408-5/32

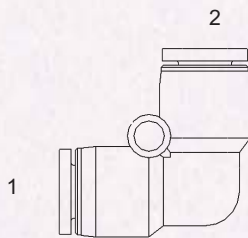

CPC-2500 - 90°

- (1) (2) Tube Union

CPC-2500-02-02
 CPC-2500-03-03
 CPC-2500-04-04
 CPC-2500-05-05
 CPC-2500-06-06
 CPC-2500-08-08
 CPC-2500-5/32-5/32

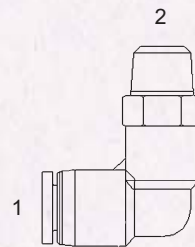

CPC-2501-S - 90°

- (1) Tube
- (2) Male Pipe Swivel

CPC-2501-S-02-01
 CPC-2501-S-02-02
 CPC-2501-S-02-04
 CPC-2501-S-02-10/32
 CPC-2501-S-03-02
 CPC-2501-S-03-04
 CPC-2501-S-03-06
 CPC-2501-S-03-10/32
 CPC-2501-S-04-01
 CPC-2501-S-04-02
 CPC-2501-S-04-04
 CPC-2501-S-04-06
 CPC-2501-S-04-10/32
 CPC-2501-S-05-02
 CPC-2501-S-05-04
 CPC-2501-S-05-06
 CPC-2501-S-06-02
 CPC-2501-S-06-04
 CPC-2501-S-06-06
 CPC-2501-S-06-08
 CPC-2501-S-08-04
 CPC-2501-S-08-06
 CPC-2501-S-08-08
 CPC-2501-S-5/32-01
 CPC-2501-S-5/32-02
 CPC-2501-S-5/32-04
 CPC-2501-S-5/32-10/32

COMPOSITE PUSH CONNECT

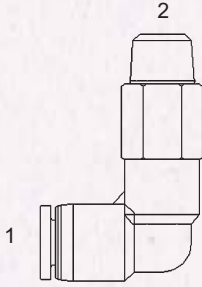

CPC-2501-S-L - 90°
 (1) Tube
 (2) Male Pipe Swivel-Long

- CPC-2501-S-L-02-02
- CPC-2501-S-L-02-04
- CPC-2501-S-L-03-02
- CPC-2501-S-L-03-04
- CPC-2501-S-L-03-06
- CPC-2501-S-L-04-02
- CPC-2501-S-L-04-04
- CPC-2501-S-L-04-06
- CPC-2501-S-L-05-02
- CPC-2501-S-L-05-04
- CPC-2501-S-L-05-06
- CPC-2501-S-L-06-04
- CPC-2501-S-L-06-06
- CPC-2501-S-L-06-08
- CPC-2501-S-L-08-04
- CPC-2501-S-L-08-06
- CPC-2501-S-L-08-08
- CPC-2501-S-L-5/32-02
- CPC-2501-S-L-5/32-04
- CPC-2501-S-L-5/32-10/32

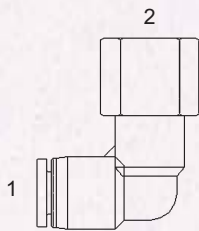

CPC-2502-S - 90°
 (1) Tube
 (2) Fem. Pipe Swivel

- CPC-2502-S-02-02
- CPC-2502-S-03-02
- CPC-2502-S-03-04
- CPC-2502-S-03-10/32
- CPC-2502-S-04-02
- CPC-2502-S-04-04
- CPC-2502-S-04-06
- CPC-2502-S-04-10/32

- CPC-2502-S-05-02
- CPC-2502-S-05-04
- CPC-2502-S-05-06
- CPC-2502-S-06-04
- CPC-2502-S-06-06
- CPC-2502-S-06-08
- CPC-2502-S-08-06
- CPC-2502-S-5/32-02
- CPC-2502-S-5/32-04
- CPC-2502-S-5/32-10/32

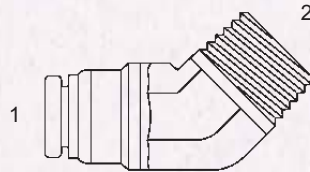

CPC-2503 - 45°
 (1) Tube
 (2) Male Pipe

- CPC-2503-04-02
- CPC-2503-04-04
- CPC-2503-06-04
- CPC-2503-06-06

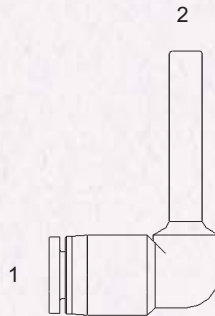

CPC-2506 - 90°
 (1) Tube
 (2) Plug-In Equal

- CPC-2506-03-03
- CPC-2506-04-04
- CPC-2506-05-05
- CPC-2506-06-06
- CPC-2506-08-08
- CPC-2506-5/32-5/32

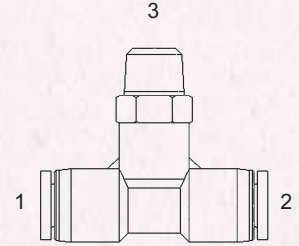

CPC-2601-S - Tee
 (1) (2) Tube
 (3) Male Pipe Swivel

- CPC-2601-S-02-02-01
- CPC-2601-S-02-02-02
- CPC-2601-S-02-02-04
- CPC-2601-S-02-02-10/32
- CPC-2601-S-03-03-02
- CPC-2601-S-03-03-04
- CPC-2601-S-03-03-06
- CPC-2601-S-03-03-10/32
- CPC-2601-S-04-04-01
- CPC-2601-S-04-04-02
- CPC-2601-S-04-04-04
- CPC-2601-S-04-04-06
- CPC-2601-S-04-04-10/32
- CPC-2601-S-05-05-02
- CPC-2601-S-05-05-04
- CPC-2601-S-05-05-06
- CPC-2601-S-06-06-02
- CPC-2601-S-06-06-04
- CPC-2601-S-06-06-06
- CPC-2601-S-06-06-08
- CPC-2601-S-08-08-02
- CPC-2601-S-08-08-04
- CPC-2601-S-08-08-06
- CPC-2601-S-08-08-08
- CPC-2601-S-5/32-5/32-01
- CPC-2601-S-5/32-5/32-02
- CPC-2601-S-5/32-5/32-04
- CPC-2601-S-5/32-5/32-10/32

COMPOSITE PUSH CONNECT

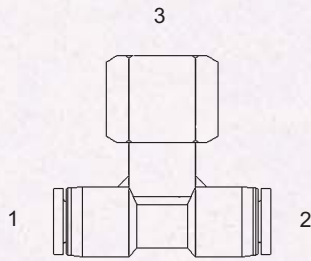

CPC-2602-S - Tee
 (1) (2) Tube
 (3) Fem. Pipe Swivel

- CPC-2602-S-02-02-02
- CPC-2602-S-03-03-02
- CPC-2602-S-03-03-04
- CPC-2602-S-04-04-02
- CPC-2602-S-04-04-04
- CPC-2602-S-05-05-02
- CPC-2602-S-05-05-04
- CPC-2602-S-05-05-06
- CPC-2602-S-06-06-04
- CPC-2602-S-06-06-06
- CPC-2602-S-08-08-06
- CPC-2602-S-08-08-08
- CPC-2602-S-5/32-5/32-02
- CPC-2602-S-5/32-5/32-04

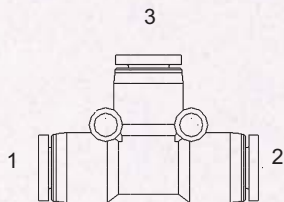

CPC-2603 - Tee
 (1) (2) (3) Tube Union

- CPC-2603-02-02-02
- CPC-2603-03-03-03
- CPC-2603-03-03-5/32
- CPC-2603-04-04-03
- CPC-2603-04-04-04
- CPC-2603-04-04-5/32
- CPC-2603-05-05-04
- CPC-2603-05-05-05
- CPC-2603-06-06-04
- CPC-2603-06-06-05
- CPC-2603-06-06-06
- CPC-2603-08-08-06
- CPC-2603-08-08-08
- CPC-2603-5/32-5/32-5/32

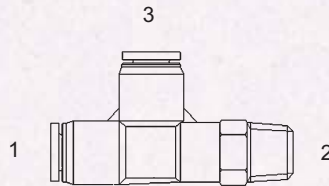

CPC-2605-S - Tee
 (1) (3) Tube
 (2) Male Pipe Swivel

- CPC-2605-S-02-01-02
- CPC-2605-S-02-02-02
- CPC-2605-S-02-04-02
- CPC-2605-S-02-10/32-02
- CPC-2605-S-03-02-03
- CPC-2605-S-03-04-03
- CPC-2605-S-03-06-03
- CPC-2605-S-03-10/32-03
- CPC-2605-S-04-01-04
- CPC-2605-S-04-02-04
- CPC-2605-S-04-04-04
- CPC-2605-S-04-06-04
- CPC-2605-S-04-10/32-04
- CPC-2605-S-05-02-05
- CPC-2605-S-05-04-05
- CPC-2605-S-05-06-05
- CPC-2605-S-06-02-06
- CPC-2605-S-06-04-06
- CPC-2605-S-06-06-06
- CPC-2605-S-06-08-06
- CPC-2605-S-08-04-08
- CPC-2605-S-08-06-08
- CPC-2605-S-08-08-08
- CPC-2605-S-5/32-02-5/32
- CPC-2605-S-5/32-04-5/32
- CPC-2605-S-5/32-10/32-5/32

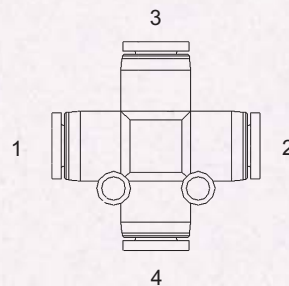

CPC-2650 - Cross
 (1) (2) (3) (4) Tube

- CPC-2650-03-03-03-03
- CPC-2650-04-04-04-04
- CPC-2650-05-05-05-05
- CPC-2650-06-06-06-06
- CPC-2650-08-08-08-08
- CPC-2650-5/32-5/32-5/32-5/32

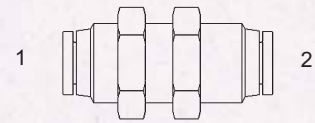

CPC-2700-LN - Str.

- (1) Tube
- (2) Bulkhead Tube
- CPC-2700-LN-02-02
- CPC-2700-LN-03-03
- CPC-2700-LN-04-04
- CPC-2700-LN-05-05
- CPC-2700-LN-06-06
- CPC-2700-LN-08-08
- CPC-2700-LN-5/32-5/32

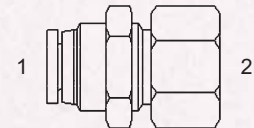

CPC-2705-LN - Str.

- (1) Bulkhead Tube
- (2) Fem. Pipe
- CPC-2705-LN-03-02
- CPC-2705-LN-03-04
- CPC-2705-LN-04-02
- CPC-2705-LN-04-04
- CPC-2705-LN-05-02
- CPC-2705-LN-05-04
- CPC-2705-LN-05-06
- CPC-2705-LN-06-04
- CPC-2705-LN-06-06
- CPC-2705-LN-08-06
- CPC-2705-LN-08-08
- CPC-2705-LN-5/32-02
- CPC-2705-LN-5/32-04

COMPOSITE PUSH CONNECT

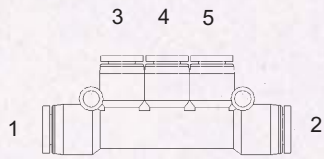

CPC-3000 - Triple Tee
(1) (2) (3) (4) (5) Tube

CPC-3000-03-03-5/32-5/32-5/32
CPC-3000-04-04-5/32-5/32-5/32
CPC-3000-05-05-03-03-03
CPC-3000-05-05-04-04-04
CPC-3000-05-05-5/32-5/32-5/32
CPC-3000-06-06-04-04-04
CPC-3000-06-06-05-05-05

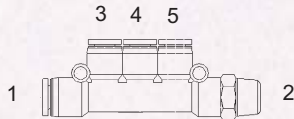

CPC-3001 - Triple Tee
(1) (3) (4) (5) Tube
(2) Male Pipe Swivel

CPC-3001-03-02-5/32-5/32-5/32
CPC-3001-04-02-5/32-5/32-5/32
CPC-3001-05-04-03-03-03
CPC-3001-05-04-04-04-04
CPC-3001-05-04-5/32-5/32-5/32
CPC-3001-06-06-04-04-04
CPC-3001-06-06-05-05-05

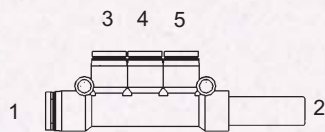

CPC-3002 - Triple Tee
(1) (3) (4) (5) Tube
(2) Plug-In

CPC-3002-03-03-5/32-5/32-5/32
CPC-3002-04-04-5/32-5/32-5/32
CPC-3002-05-05-03-03-03
CPC-3002-05-05-04-04-04
CPC-3002-05-05-5/32-5/32-5/32
CPC-3002-06-06-04-04-04
CPC-3002-06-06-05-05-05

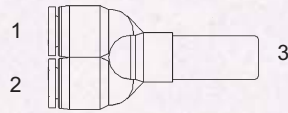

CPC-4107 - "Y"
(1) (2) (3) Tube Union

CPC-4107-02-02-02
CPC-4107-03-03-03
CPC-4107-03-03-04
CPC-4107-04-04-04
CPC-4107-04-04-05
CPC-4107-04-04-06
CPC-4107-05-05-05
CPC-4107-05-05-06
CPC-4107-06-06-06
CPC-4107-06-06-08
CPC-4107-08-08-08
CPC-4107-5/32-5/32-03
CPC-4107-5/32-5/32-04
CPC-4107-5/32-5/32-5/32

COMPOSITE PUSH CONNECT

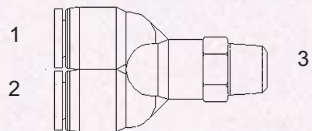

CPC-4108-S - "Y"
 (1) (2) Tube
 (3) Male Pipe Swivel

- CPC-4108-S-03-03-02
- CPC-4108-S-03-03-04
- CPC-4108-S-03-03-06
- CPC-4108-S-03-03-10/32
- CPC-4108-S-04-04-02
- CPC-4108-S-04-04-04
- CPC-4108-S-04-04-06
- CPC-4108-S-04-04-10/32
- CPC-4108-S-05-05-02
- CPC-4108-S-05-05-04
- CPC-4108-S-05-05-06
- CPC-4108-S-06-06-04
- CPC-4108-S-06-06-06
- CPC-4108-S-06-06-08
- CPC-4108-S-08-08-04
- CPC-4108-S-08-08-06
- CPC-4108-S-08-08-08
- CPC-4108-S-5/32-5/32-02
- CPC-4108-S-5/32-5/32-04
- CPC-4108-S-5/32-5/32-10/32

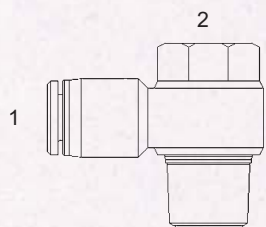

CPC-4110 - Banjo
 (1) Tube
 (2) Male Banjo Swivel

- CPC-4110-03-02
- CPC-4110-03-04
- CPC-4110-03-06
- CPC-4110-03-10/32
- CPC-4110-04-02
- CPC-4110-04-04
- CPC-4110-04-06
- CPC-4110-05-02
- CPC-4110-05-04
- CPC-4110-05-06
- CPC-4110-06-04
- CPC-4110-06-06
- CPC-4110-08-06
- CPC-4110-08-08
- CPC-4110-5/32-02
- CPC-4110-5/32-10/32

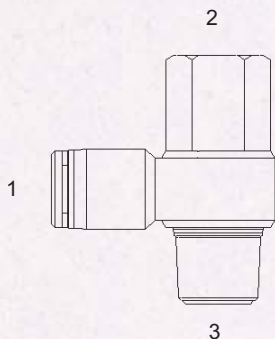

CPC-4111 - Banjo
 (1) Tube
 (2) Fem. Pipe
 (2) Fem. Banjo Swivel

- CPC-4111-03-02-02
- CPC-4111-03-04-04
- CPC-4111-03-10/32-10/32
- CPC-4111-04-02-02
- CPC-4111-04-04-04
- CPC-4111-05-02-02
- CPC-4111-05-04-04
- CPC-4111-05-06-06
- CPC-4111-06-04-04
- CPC-4111-06-06-06
- CPC-4111-08-06-06
- CPC-4111-08-08-08
- CPC-4111-5/32-02-02
- CPC-4111-5/32-10/32-10/32

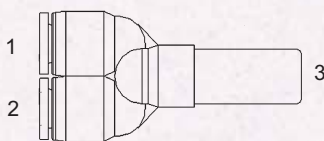

CPC-4112 - "Y"
 (1) (2) Tube
 (3) Plug-In

- CPC-4112-03-03-03
- CPC-4112-04-04-04
- CPC-4112-04-04-05
- CPC-4112-04-04-06
- CPC-4112-05-05-05
- CPC-4112-05-05-06
- CPC-4112-06-06-06
- CPC-4112-06-06-08
- CPC-4112-08-08-08
- CPC-4112-5/32-5/32-04
- CPC-4112-5/32-5/32-5/32

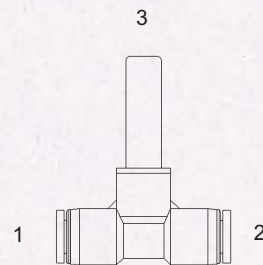

CPC-4133 - Tee
 (1) (2) Tube
 (3) Plug-In

- CPC-4133-03-03-03
- CPC-4133-04-04-04
- CPC-4133-04-04-05
- CPC-4133-04-04-06
- CPC-4133-05-05-05
- CPC-4133-05-05-06
- CPC-4133-06-06-06
- CPC-4133-06-06-08
- CPC-4133-08-08-08
- CPC-4133-5/32-5/32-04
- CPC-4133-5/32-5/32-5/32



CPC-4135 - Tee
 (1) (3) Tube
 (2) Plug-In

- CPC-4135-03-03-03
- CPC-4135-04-04-04
- CPC-4135-04-04-05
- CPC-4135-04-04-06
- CPC-4135-05-05-05
- CPC-4135-05-05-06
- CPC-4135-06-06-06
- CPC-4135-06-06-08
- CPC-4135-08-08-08
- CPC-4135-5/32-5/32-04
- CPC-4135-5/32-5/32-5/32

SHORT BODY COMPACT

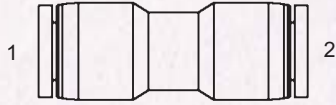

CPC-SB-2403 - Str.
(1) (2) Tube Union

CPC-SB-2403-02-02
CPC-SB-2403-04-02
CPC-SB-2403-04-04
CPC-SB-2403-04-5/32
CPC-SB-2403-04-06
CPC-SB-2403-06-04
CPC-SB-2403-06-06
CPC-SB-2403-08-06
CPC-SB-2403-08-08
CPC-SB-2403-5/32-02
CPC-SB-2403-5/32-5/32

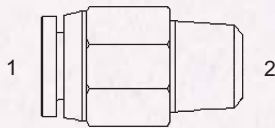

CPC-SB-2404 - Str.
(1) Tube
(2) Male Pipe

CPC-SB-2404-02-01
CPC-SB-2404-02-02
CPC-SB-2404-02-10/32
CPC-SB-2404-04-01
CPC-SB-2404-04-02
CPC-SB-2404-04-10/32
CPC-SB-2404-5/32-01
CPC-SB-2404-5/32-02
CPC-SB-2404-5/32-10/32

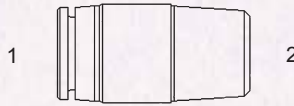

CPC-SB-2404-NH - Str.
No Hex (Round)
(1) Tube
(2) Male Pipe

CPC-SB-2404-NH-02-01
CPC-SB-2404-NH-02-02
CPC-SB-2404-NH-02-10/32
CPC-SB-2404-NH-04-01
CPC-SB-2404-NH-04-02
CPC-SB-2404-NH-04-04
CPC-SB-2404-NH-04-10/32
CPC-SB-2404-NH-5/32-01
CPC-SB-2404-NH-5/32-02
CPC-SB-2404-NH-5/32-10/32

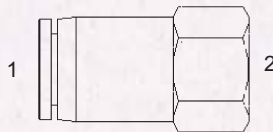

CPC-SB-2405 - Str.
(1) Tube
(2) Fem. Pipe

CPC-SB-2405-02-01
CPC-SB-2405-02-10/32
CPC-SB-2405-5/32-01
CPC-SB-2405-5/32-10/32

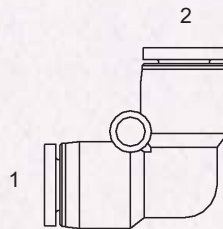

CPC-SB-2500 - 90°
(1) (2) Tube Union

CPC-SB-2500-02-02
CPC-SB-2500-04-04
CPC-SB-2500-06-06
CPC-SB-2500-08-08
CPC-SB-2500-5/32-5/32

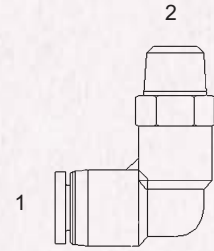

CPC-SB-2501-S - 90°
(1) Tube
(2) Male Pipe Swivel

CPC-SB-2501-S-02-01
CPC-SB-2501-S-02-02
CPC-SB-2501-S-02-04
CPC-SB-2501-S-02-10/32
CPC-SB-2501-S-04-01
CPC-SB-2501-S-04-02
CPC-SB-2501-S-04-04
CPC-SB-2501-S-04-06
CPC-SB-2501-S-04-10/32
CPC-SB-2501-S-06-02
CPC-SB-2501-S-06-04
CPC-SB-2501-S-06-06
CPC-SB-2501-S-06-08
CPC-SB-2501-S-08-04
CPC-SB-2501-S-08-06
CPC-SB-2501-S-08-08
CPC-SB-2501-S-5/32-01
CPC-SB-2501-S-5/32-02
CPC-SB-2501-S-5/32-04
CPC-SB-2501-S-5/32-10/32

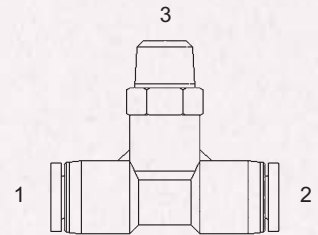

CPC-SB-2601-S - Tee
(1) (2) Tube
(3) Male Pipe Swivel

CPC-SB-2601-S-02-02-01
CPC-SB-2601-S-02-02-02
CPC-SB-2601-S-02-02-10/32
CPC-SB-2601-S-04-04-01
CPC-SB-2601-S-04-04-02
CPC-SB-2601-S-04-04-04
CPC-SB-2601-S-04-04-06
CPC-SB-2601-S-04-04-10/32
CPC-SB-2601-S-06-06-02
CPC-SB-2601-S-06-06-04
CPC-SB-2601-S-06-06-06
CPC-SB-2601-S-06-06-08
CPC-SB-2601-S-08-08-04
CPC-SB-2601-S-08-08-06
CPC-SB-2601-S-08-08-08
CPC-SB-2601-S-5/32-5/32-01
CPC-SB-2601-S-5/32-5/32-02
CPC-SB-2601-S-5/32-5/32-04
CPC-SB-2601-S-5/32-5/32-10/32

SHORT BODY COMPACT

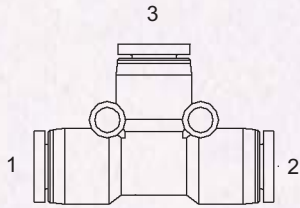

CPC-SB-2603 - Tee
(1) (2) (3) Tube Union

CPC-SB-2603-02-02-02
CPC-SB-2603-04-04-04
CPC-SB-2603-06-06-06
CPC-SB-2603-08-08-08
CPC-SB-2603-5/32-5/32-5/32

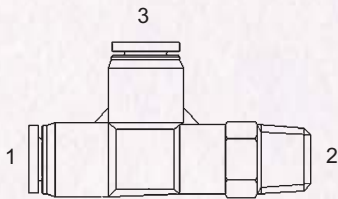

CPC-SB-2605-S - Tee
(1) (3) Tube
(2) Male Pipe Swivel

CPC-SB-2605-S-02-01-02
CPC-SB-2605-S-02-02-02
CPC-SB-2605-S-02-10/32-02
CPC-SB-2605-S-04-01-04
CPC-SB-2605-S-04-02-04
CPC-SB-2605-S-04-04-04
CPC-SB-2605-S-04-10/32-04
CPC-SB-2605-S-06-02-06
CPC-SB-2605-S-06-04-06
CPC-SB-2605-S-06-06-06
CPC-SB-2605-S-06-08-06
CPC-SB-2605-S-08-04-08
CPC-SB-2605-S-08-06-08
CPC-SB-2605-S-08-08-08
CPC-SB-2605-S-5/32-01-5/32
CPC-SB-2605-S-5/32-02-5/32
CPC-SB-2605-S-5/32-10/32-5/32

SPEED CONTROL

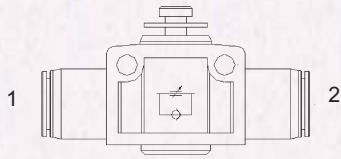

CPC-SC-2403

(1) (2) Tube

CPC-SC-2403-03-03
CPC-SC-2403-04-04
CPC-SC-2403-05-05
CPC-SC-2403-06-06
CPC-SC-2403-08-08
CPC-SC-2403-5/32-5/32

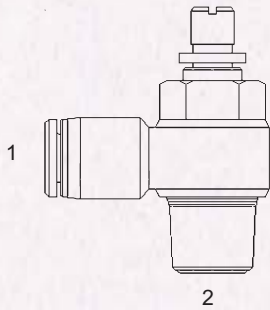

CPC-SC-2501-S

(1) Tube

(2) Male Pipe

CPC-SC-2501-S-03-02
CPC-SC-2501-S-03-04
CPC-SC-2501-S-03-06
CPC-SC-2501-S-03-10/32
CPC-SC-2501-S-04-02
CPC-SC-2501-S-04-04
CPC-SC-2501-S-04-06
CPC-SC-2501-S-04-10/32
CPC-SC-2501-S-05-02
CPC-SC-2501-S-05-04
CPC-SC-2501-S-05-06
CPC-SC-2501-S-05-08
CPC-SC-2501-S-06-04
CPC-SC-2501-S-06-06
CPC-SC-2501-S-06-08
CPC-SC-2501-S-08-06
CPC-SC-2501-S-08-08
CPC-SC-2501-S-5/32-02
CPC-SC-2501-S-5/32-04
CPC-SC-2501-S-5/32-10/32



1-800-348-8467