



Features:

- Convenient One touch fittings provide instant tubing connections.
- Elliptical release ring facilitates pneumatic installations in confined spaces. Light manual pressure on the elliptical release ring is all that is required to instantly disconnect each tube. No special tools required.
- Nickel-plated brass threaded bodies ensures anti-corrosion and anti-contamination.
- All NPT & BSPT thread are pre-coated with sealant and require no additional sealing.
- Most all models available in inch and metric size.

Specifications:

Fluid Type	Air (No other type of gas or liquid)	
Working Pressure Range	0~150PSI	0~9.9KgF/cm2(0~990KPa)
Negative Pressure	-29.5 in Hg	-750mm Hg(10 Torr)<8
Working Temperature	32~140 degree F	0-60 degree C
Recommended tube material	Nylon and Polyurethane	

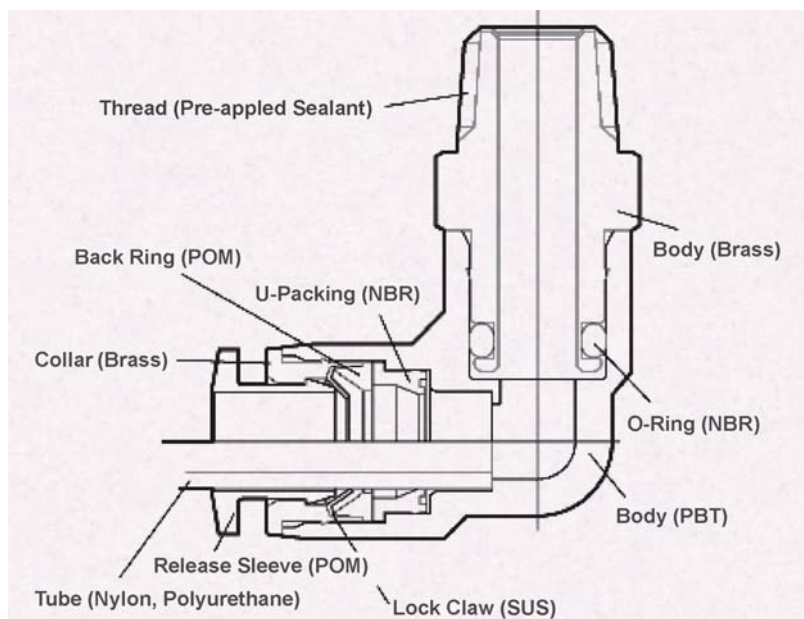





# COMPOSITE PUSH CONNECT

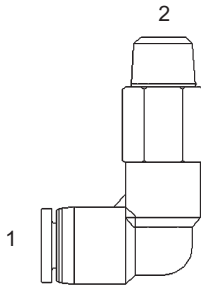

**CPC-2501-S-L - 90°**  
 (1) Tube  
 (2) Male Pipe Swivel-Long

- CPC-2501-S-L-02-02
- CPC-2501-S-L-02-04
- CPC-2501-S-L-03-02
- CPC-2501-S-L-03-04
- CPC-2501-S-L-03-06
- CPC-2501-S-L-04-02
- CPC-2501-S-L-04-04
- CPC-2501-S-L-04-06
- CPC-2501-S-L-05-02
- CPC-2501-S-L-05-04
- CPC-2501-S-L-05-06
- CPC-2501-S-L-06-04
- CPC-2501-S-L-06-06
- CPC-2501-S-L-06-08
- CPC-2501-S-L-08-04
- CPC-2501-S-L-08-06
- CPC-2501-S-L-08-08
- CPC-2501-S-L-5/32-02
- CPC-2501-S-L-5/32-04
- CPC-2501-S-L-5/32-10/32

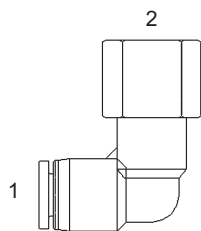

**CPC-2502-S - 90°**  
 (1) Tube  
 (2) Fem. Pipe Swivel

- CPC-2502-S-02-02
- CPC-2502-S-03-02
- CPC-2502-S-03-04
- CPC-2502-S-03-10/32
- CPC-2502-S-04-02
- CPC-2502-S-04-04
- CPC-2502-S-04-06
- CPC-2502-S-04-10/32

- CPC-2502-S-05-02
- CPC-2502-S-05-04
- CPC-2502-S-05-06
- CPC-2502-S-06-04
- CPC-2502-S-06-06
- CPC-2502-S-06-08
- CPC-2502-S-08-06
- CPC-2502-S-5/32-02
- CPC-2502-S-5/32-04
- CPC-2502-S-5/32-10/32

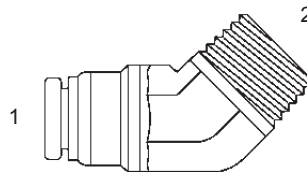

**CPC-2503 - 45°**  
 (1) Tube  
 (2) Male Pipe

- CPC-2503-04-02
- CPC-2503-04-04
- CPC-2503-06-04
- CPC-2503-06-06

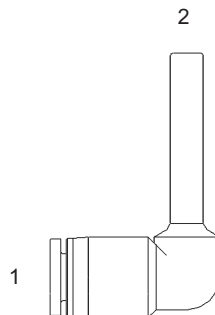

**CPC-2506 - 90°**  
 (1) Tube  
 (2) Plug-In Equal

- CPC-2506-03-03
- CPC-2506-04-04
- CPC-2506-05-05
- CPC-2506-06-06
- CPC-2506-08-08
- CPC-2506-5/32-5/32

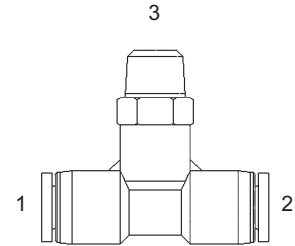

**CPC-2601-S - Tee**  
 (1) (2) Tube  
 (3) Male Pipe Swivel

- CPC-2601-S-02-02-01
- CPC-2601-S-02-02-02
- CPC-2601-S-02-02-04
- CPC-2601-S-02-02-10/32
- CPC-2601-S-03-03-02
- CPC-2601-S-03-03-04
- CPC-2601-S-03-03-06
- CPC-2601-S-03-03-10/32
- CPC-2601-S-04-04-01
- CPC-2601-S-04-04-02
- CPC-2601-S-04-04-04
- CPC-2601-S-04-04-06
- CPC-2601-S-04-04-10/32
- CPC-2601-S-05-05-02
- CPC-2601-S-05-05-04
- CPC-2601-S-05-05-06
- CPC-2601-S-06-06-02
- CPC-2601-S-06-06-04
- CPC-2601-S-06-06-06
- CPC-2601-S-06-06-08
- CPC-2601-S-08-08-02
- CPC-2601-S-08-08-04
- CPC-2601-S-08-08-06
- CPC-2601-S-08-08-08
- CPC-2601-S-5/32-5/32-01
- CPC-2601-S-5/32-5/32-02
- CPC-2601-S-5/32-5/32-04
- CPC-2601-S-5/32-5/32-10/32

# COMPOSITE PUSH CONNECT

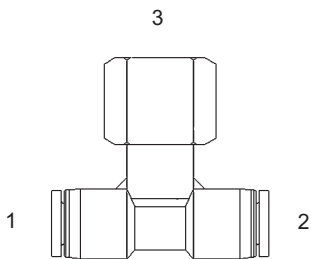

**CPC-2602-S - Tee**  
 (1) (2) Tube  
 (3) Fem. Pipe Swivel

- CPC-2602-S-02-02-02
- CPC-2602-S-03-03-02
- CPC-2602-S-03-03-04
- CPC-2602-S-04-04-02
- CPC-2602-S-04-04-04
- CPC-2602-S-05-05-02
- CPC-2602-S-05-05-04
- CPC-2602-S-05-05-06
- CPC-2602-S-06-06-04
- CPC-2602-S-06-06-06
- CPC-2602-S-08-08-06
- CPC-2602-S-08-08-08
- CPC-2602-S-5/32-5/32-02
- CPC-2602-S-5/32-5/32-04

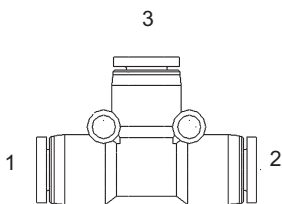

**CPC-2603 - Tee**  
 (1) (2) (3) Tube Union

- CPC-2603-02-02-02
- CPC-2603-03-03-03
- CPC-2603-03-03-5/32
- CPC-2603-04-04-03
- CPC-2603-04-04-04
- CPC-2603-04-04-5/32
- CPC-2603-05-05-04
- CPC-2603-05-05-05
- CPC-2603-06-06-04
- CPC-2603-06-06-05
- CPC-2603-06-06-06
- CPC-2603-08-08-06
- CPC-2603-08-08-08
- CPC-2603-5/32-5/32-5/32

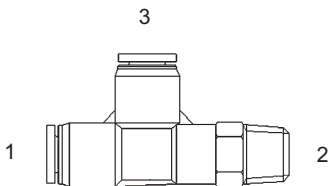

**CPC-2605-S - Tee**  
 (1) (3) Tube  
 (2) Male Pipe Swivel

- CPC-2605-S-02-01-02
- CPC-2605-S-02-02-02
- CPC-2605-S-02-04-02
- CPC-2605-S-02-10/32-02
- CPC-2605-S-03-02-03
- CPC-2605-S-03-04-03
- CPC-2605-S-03-06-03
- CPC-2605-S-03-10/32-03
- CPC-2605-S-04-01-04
- CPC-2605-S-04-02-04
- CPC-2605-S-04-04-04
- CPC-2605-S-04-06-04
- CPC-2605-S-04-10/32-04
- CPC-2605-S-05-02-05
- CPC-2605-S-05-04-05
- CPC-2605-S-05-06-05
- CPC-2605-S-06-02-06
- CPC-2605-S-06-04-06
- CPC-2605-S-06-06-06
- CPC-2605-S-06-08-06
- CPC-2605-S-08-04-08
- CPC-2605-S-08-06-08
- CPC-2605-S-08-08-08
- CPC-2605-S-5/32-02-5/32
- CPC-2605-S-5/32-04-5/32
- CPC-2605-S-5/32-10/32-5/32

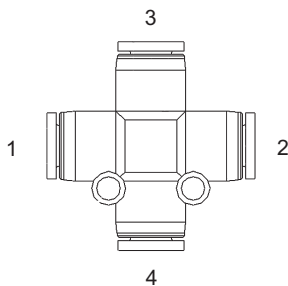

**CPC-2650 - Cross**  
 (1) (2) (3) (4) Tube

- CPC-2650-03-03-03-03
- CPC-2650-04-04-04-04
- CPC-2650-05-05-05-05
- CPC-2650-06-06-06-06
- CPC-2650-08-08-08-08
- CPC-2650-5/32-5/32-5/32-5/32

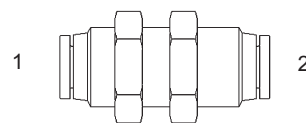

**CPC-2700-LN - Str.**  
 (1) Tube  
 (2) Bulkhead Tube  
 CPC-2700-LN-02-02  
 CPC-2700-LN-03-03  
 CPC-2700-LN-04-04  
 CPC-2700-LN-05-05  
 CPC-2700-LN-06-06  
 CPC-2700-LN-08-08  
 CPC-2700-LN-5/32-5/32

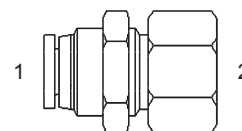

**CPC-2705-LN - Str.**  
 (1) Bulkhead Tube  
 (2) Fem. Pipe  
 CPC-2705-LN-03-02  
 CPC-2705-LN-03-04  
 CPC-2705-LN-04-02  
 CPC-2705-LN-04-04  
 CPC-2705-LN-05-02  
 CPC-2705-LN-05-04  
 CPC-2705-LN-05-06  
 CPC-2705-LN-06-04  
 CPC-2705-LN-06-06  
 CPC-2705-LN-08-06  
 CPC-2705-LN-08-08  
 CPC-2705-LN-5/32-02  
 CPC-2705-LN-5/32-04

# COMPOSITE PUSH CONNECT

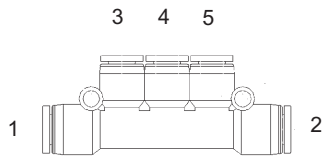

**CPC-3000 - Triple Tee**  
(1) (2) (3) (4) (5) Tube

CPC-3000-03-03-5/32-5/32-5/32  
CPC-3000-04-04-5/32-5/32-5/32  
CPC-3000-05-05-03-03-03  
CPC-3000-05-05-04-04-04  
CPC-3000-05-05-5/32-5/32-5/32  
CPC-3000-06-06-04-04-04  
CPC-3000-06-06-05-05-05

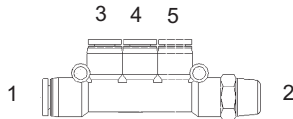

**CPC-3001 - Triple Tee**  
(1) (3) (4) (5) Tube  
(2) Male Pipe Swivel

CPC-3001-03-02-5/32-5/32-5/32  
CPC-3001-04-02-5/32-5/32-5/32  
CPC-3001-05-04-03-03-03  
CPC-3001-05-04-04-04-04  
CPC-3001-05-04-5/32-5/32-5/32  
CPC-3001-06-06-04-04-04  
CPC-3001-06-06-05-05-05

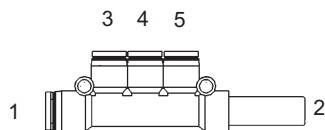

**CPC-3002 - Triple Tee**  
(1) (3) (4) (5) Tube  
(2) Plug-In

CPC-3002-03-03-5/32-5/32-5/32  
CPC-3002-04-04-5/32-5/32-5/32  
CPC-3002-05-05-03-03-03  
CPC-3002-05-05-04-04-04  
CPC-3002-05-05-5/32-5/32-5/32  
CPC-3002-06-06-04-04-04  
CPC-3002-06-06-05-05-05

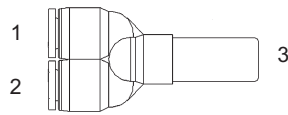

**CPC-4107 - "Y"**  
(1) (2) (3) Tube Union

CPC-4107-02-02-02  
CPC-4107-03-03-03  
CPC-4107-03-03-04  
CPC-4107-04-04-04  
CPC-4107-04-04-05  
CPC-4107-04-04-06  
CPC-4107-05-05-05  
CPC-4107-05-05-06  
CPC-4107-06-06-06  
CPC-4107-06-06-08  
CPC-4107-08-08-08  
CPC-4107-5/32-5/32-03  
CPC-4107-5/32-5/32-04  
CPC-4107-5/32-5/32-5/32











