

FUI FITTINGS UNLIMITED^{INC}

Adapter & Fitting Specialist

www.myfui.com

Standard Parts List

CORPORATE SALES

DALLAS, TX

3000 AVENUE F

ARLINGTON, TX 76011

(800) 348-8467 (281) 500-9570 FAX

CLEVELAND, OH

(800) 348-8467 (817) 860-8517 FAX

HOUSTON, TX

(800) 633-5340 (281) 500-9570 FAX

SALT LAKE CITY, UT

(800) 348-8467 (817) 860-8517 FAX

CANADA -AURORA, ONTARIO

(877) 644-4403 (905) 713-3927 FAX

ATLANTA, GA

(800) 348-8467 (817) 860-8517 FAX

- TERMS -** All invoices are 2%-10 Net 30 with approved credit. A 1½% finance charge will be assessed on all past due accounts. All accounts due and payable in Arlington, Tarrant County, Texas.
- MINIMUM ORDER -** \$25.00 per order
- POR -** Price On Request
- RETURNS -** Fittings may be returned only with authorization from FITTINGS UNLIMITED, INC. - subject to our inspection and must be shipped freight prepaid within 30 days of original shipment. A restocking fee of 20% or \$10.00, whichever is greater, will apply. In case of shipping errors, notification must be made within 30 days to receive an adjustment. Special fittings and made to order items are non-cancelable and not returnable without written consent of FITTINGS UNLIMITED, INC.



Steel Live Swivels

*“It is the policy of Fittings Unlimited, Inc.
to maintain and improve our customer satisfaction by
providing hydraulic and pneumatic fittings and
accessories that consistently meet our customer’s
specified product and delivery requirements.”*

STEEL LIVE SWIVELS

Styles may vary from picture

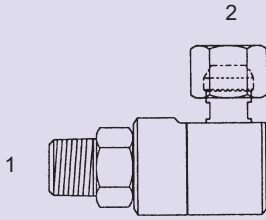

SLS-1501 - 90°

- (1) Male Pipe - Stem
- (2) Fem. Pipe Swivel - Barrel

- SLS-1501-04-04
- SLS-1501-04-06
- SLS-1501-06-04
- SLS-1501-06-06
- SLS-1501-08-08
- SLS-1501-12-12
- SLS-1501-16-16
- SLS-1501-20-20
- SLS-1501-24-24
- SLS-1501-32-32

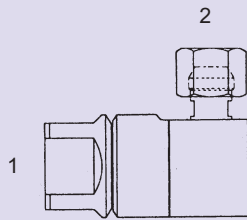

SLS-1502 - 90°

- (1) Fem. Pipe - Stem
- (2) Fem. Pipe Swivel - Barrel

- SLS-1502-04-04
- SLS-1502-04-06
- SLS-1502-06-04
- SLS-1502-06-06
- SLS-1502-08-08
- SLS-1502-12-12
- SLS-1502-16-16
- SLS-1502-20-20
- SLS-1502-24-24
- SLS-1502-32-32

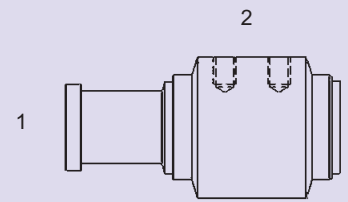

SLS-1704-61 - 90°

- (1) O-Ring Flange Head - Stem
- (2) Flange Block - Tapped Holes - Barrel
Code 61

- SLS-1704-61-12-12
- SLS-1704-61-16-16
- SLS-1704-61-20-20
- SLS-1704-61-24-24
- SLS-1704-61-32-32
- SLS-1704-61-40-40

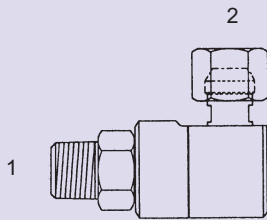

SLS-1501-4K - 90°

- 4000 PSI
- (1) Male Pipe - Stem
- (2) Fem. Pipe Swivel - Barrel

- SLS-1501-4K-08-08

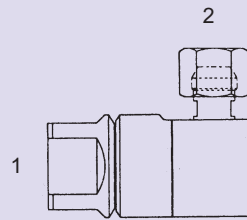

SLS-1502-4K - 90°

- 4000 PSI
- (1) Fem. Pipe - Stem
- (2) Fem. Pipe Swivel - Barrel

- SLS-1502-4K-08-08

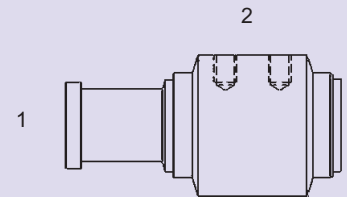

SLS-1704-62 - 90°

- (1) O-Ring Flange Head - Stem
- (2) Flange Block - Tapped Holes - Barrel
Code 62

- SLS-1704-62-08-08
- SLS-1704-62-12-12
- SLS-1704-62-16-16
- SLS-1704-62-20-20
- SLS-1704-62-24-24
- SLS-1704-62-32-32

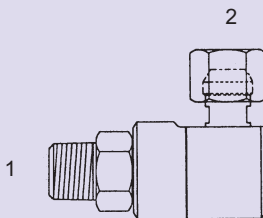

SLS-1501-5K - 90°

- 5000 PSI
- (1) Male Pipe - Stem
- (2) Fem. Pipe Swivel - Barrel

- SLS-1501-5K-04-04
- SLS-1501-5K-06-06

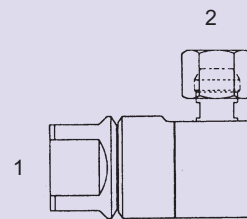

SLS-1502-5K - 90°

- 5000 PSI
- (1) Fem. Pipe - Stem
- (2) Fem. Pipe Swivel - Barrel

- SLS-1502-5K-06-06

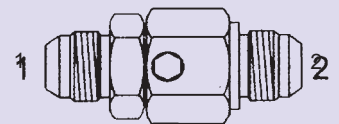

SLS-2403 - Str.

- (1) Male JIC - Stem
- (2) Male JIC - Barrel

- SLS-2403-06-06
- SLS-2403-08-08
- SLS-2403-10-10
- SLS-2403-12-12
- SLS-2403-16-16
- SLS-2403-20-20
- SLS-2403-24-24
- SLS-2403-32-32

STEEL LIVE SWIVELS

Styles may vary from picture

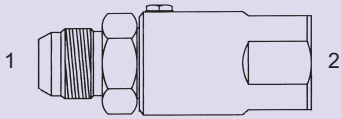

SLS-2405 - Str.

- (1) Male JIC- Stem
- (2) Fem. Pipe - Barrel

- SLS-2405-04-04
- SLS-2405-06-04
- SLS-2405-08-06
- SLS-2405-08-08
- SLS-2405-10-08
- SLS-2405-12-12
- SLS-2405-16-16
- SLS-2405-20-20
- SLS-2405-24-24

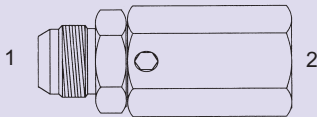

SLS-2412 - Str.

- (1) Male JIC- Stem
- (2) Fem. JIC - Barrel

- SLS-2412-04-04
- SLS-2412-06-06
- SLS-2412-08-08
- SLS-2412-10-10
- SLS-2412-12-12
- SLS-2412-16-16
- SLS-2412-20-20

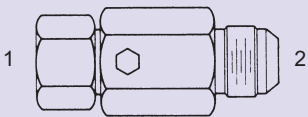

SLS-2421 - Str.

- (1) Fem. JIC- Stem
- (2) Male JIC - Barrel

- SLS-2421-06-06
- SLS-2421-08-06
- SLS-2421-08-08
- SLS-2421-10-10
- SLS-2421-12-12
- SLS-2421-14-14
- SLS-2421-16-16
- SLS-2421-20-20
- SLS-2421-24-24
- SLS-2421-32-32

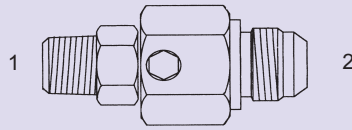

SLS-2471 - Str.

- (1) Male Pipe - Stem
- (2) Male JIC - Barrel

- SLS-2471-04-04
- SLS-2471-04-06
- SLS-2471-04-08
- SLS-2471-06-06
- SLS-2471-06-08
- SLS-2471-08-08
- SLS-2471-08-10
- SLS-2471-08-12
- SLS-2471-12-10
- SLS-2471-12-12
- SLS-2471-16-16
- SLS-2471-20-20
- SLS-2471-24-24
- SLS-2471-32-32

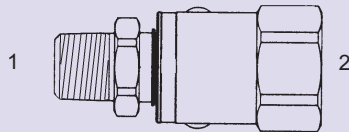

SLS-2472 - Str.

- (1) Male Pipe - Stem
- (2) Fem. JIC - Barrel

- SLS-2472-06-06
- SLS-2472-08-08

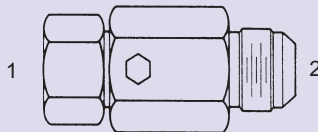

SLS-2481 - Str.

- (1) Fem. Pipe - Stem
- (2) Male JIC - Barrel

- SLS-2481-04-04
- SLS-2481-04-06
- SLS-2481-06-06
- SLS-2481-06-08
- SLS-2481-08-08
- SLS-2481-08-10
- SLS-2481-08-12
- SLS-2481-12-10
- SLS-2481-12-12
- SLS-2481-16-16
- SLS-2481-20-20
- SLS-2481-24-24
- SLS-2481-32-32

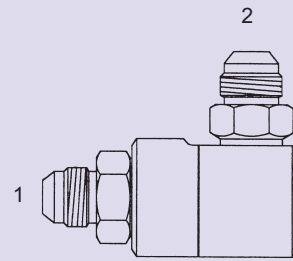

SLS-2500 - 90°

- (1) Male JIC - Stem
- (2) Male JIC - Barrel

- SLS-2500-04-04
- SLS-2500-05-05
- SLS-2500-05-06
- SLS-2500-06-05
- SLS-2500-06-06
- SLS-2500-06-08
- SLS-2500-08-06
- SLS-2500-08-08
- SLS-2500-08-10
- SLS-2500-10-08
- SLS-2500-10-10
- SLS-2500-12-12
- SLS-2500-16-16
- SLS-2500-20-20
- SLS-2500-24-24
- SLS-2500-32-32

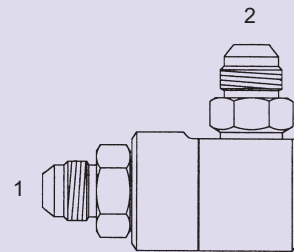

SLS-2500-4K - 90°

- 4000 PSI
- (1) Male JIC - Stem
- (2) Male JIC - Barrel

- SLS-2500-4K-12-12

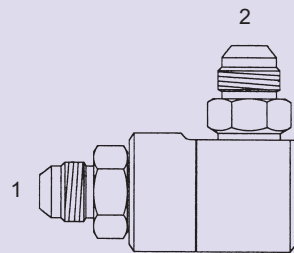

SLS-2500-5K - 90°

- 5000 PSI
- (1) Male JIC - Stem
- (2) Male JIC - Barrel

- SLS-2500-5K-05-05
- SLS-2500-5K-05-06
- SLS-2500-5K-06-05
- SLS-2500-5K-06-06
- SLS-2500-5K-06-08
- SLS-2500-5K-08-06
- SLS-2500-5K-08-08
- SLS-2500-5K-08-10
- SLS-2500-5K-10-08
- SLS-2500-5K-10-10

STEEL LIVE SWIVELS

Styles may vary from picture

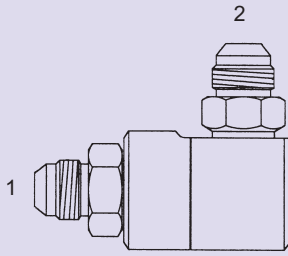

SLS-2500-LH - 90°

- Large Hex
- (1) Male JIC - Stem
- (2) Male JIC - Barrel

SLS-2500-LH-08-08

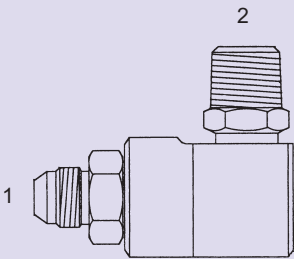

SLS-2501 - 90°

- (1) Male JIC - Stem
- (2) Male Pipe - Barrel

- SLS-2501-04-04
- SLS-2501-05-04
- SLS-2501-05-06
- SLS-2501-06-04
- SLS-2501-06-06
- SLS-2501-08-06
- SLS-2501-08-08
- SLS-2501-10-06
- SLS-2501-10-08
- SLS-2501-12-12
- SLS-2501-16-16
- SLS-2501-20-20
- SLS-2501-24-24
- SLS-2501-32-32

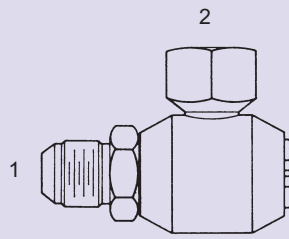

SLS-2502 - 90°

- (1) Male JIC - Stem
- (2) Fem. Pipe - Barrel

- SLS-2502-04-04
- SLS-2502-05-06
- SLS-2502-06-04
- SLS-2502-06-06
- SLS-2502-08-06
- SLS-2502-08-08
- SLS-2502-10-08
- SLS-2502-12-12
- SLS-2502-16-16
- SLS-2502-20-20
- SLS-2502-24-24
- SLS-2502-32-32

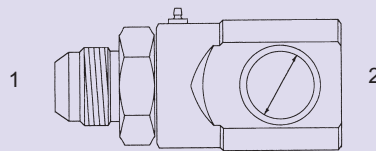

SLS-2502-SB - 90°

- (1) Male JIC - Stem
- (2) Fem. Pipe - Barrel
- (Short Body)

- SLS-2502-SB-08-06
- SLS-2502-SB-10-06
- SLS-2502-SB-10-08
- SLS-2502-SB-12-12
- SLS-2502-SB-16-16
- SLS-2502-SB-20-20
- SLS-2502-SB-24-24

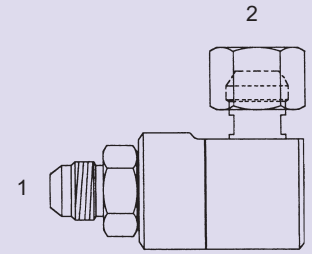

SLS-2519 - 90°

- (1) Male JIC - Stem
- (2) Fem. Pipe Swivel - Barrel

- SLS-2519-05-04
- SLS-2519-05-06
- SLS-2519-06-04
- SLS-2519-06-06
- SLS-2519-08-04
- SLS-2519-08-06
- SLS-2519-08-08
- SLS-2519-10-08
- SLS-2519-12-12
- SLS-2519-16-16
- SLS-2519-20-20
- SLS-2519-24-24
- SLS-2519-32-32

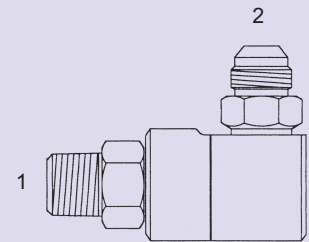

SLS-2571 - 90°

- (1) Male Pipe - Stem
- (2) Male JIC - Barrel

- SLS-2571-04-04
- SLS-2571-04-05
- SLS-2571-04-06
- SLS-2571-04-08
- SLS-2571-06-05
- SLS-2571-06-06
- SLS-2571-06-08
- SLS-2571-08-08
- SLS-2571-08-10
- SLS-2571-12-12
- SLS-2571-16-16
- SLS-2571-20-20
- SLS-2571-24-24
- SLS-2571-32-32

STEEL LIVE SWIVELS

Styles may vary from picture

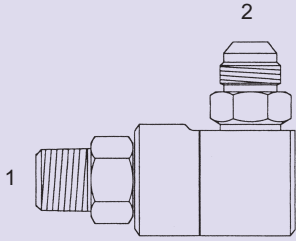

SLS-2571-4K - 90°

4000 PSI

- (1) Male Pipe - Stem
- (2) Male JIC - Barrel

SLS-2571-4K-12-12

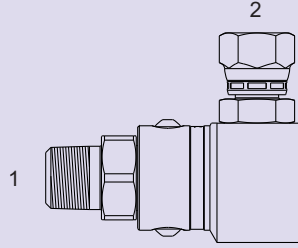

SLS-2573-4K - 90°

4000 PSI

- (1) Male Pipe - Stem
- (2) Female JIC - Barrel

SLS-2573-4K-12-12

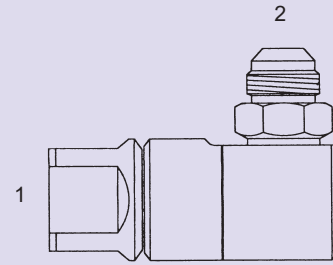

SLS-2581-4K - 90°

4000 PSI

- (1) Fem. Pipe - Stem
- (2) Male JIC - Barrel

SLS-2581-4K-12-12

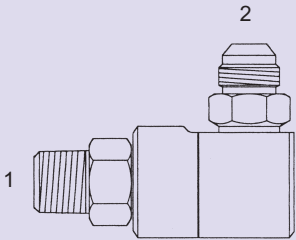

SLS-2571-5K - 90°

5000 PSI

- (1) Male Pipe - Stem
- (2) Male JIC - Barrel

SLS-2571-5K-04-04

SLS-2571-5K-06-06

SLS-2571-5K-08-08

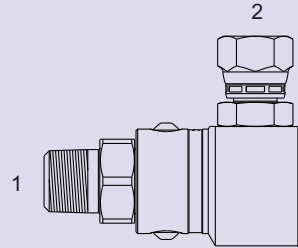

SLS-2573-5K - 90°

5000 PSI

- (1) Male Pipe - Stem
- (2) Female JIC - Barrel

SLS-2573-5K-08-08

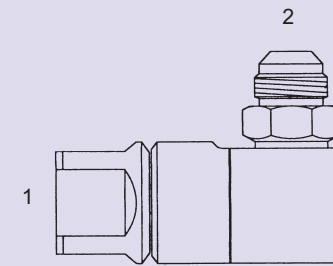

SLS-2581-5K - 90°

5000 PSI

- (1) Fem. Pipe - Stem
- (2) Male JIC - Barrel

SLS-2581-5K-06-06

SLS-2581-5K-08-08

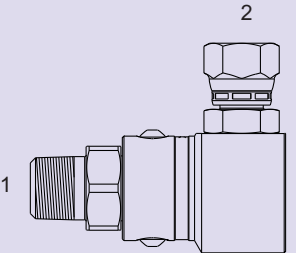

SLS-2573 - 90°

- (1) Male Pipe - Stem
- (2) Female JIC - Barrel

SLS-2573-16-16

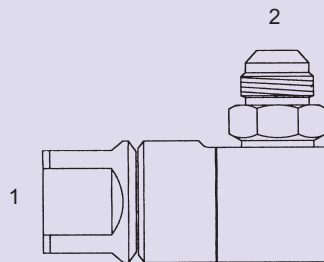

SLS-2581 - 90°

- (1) Fem. Pipe - Stem
- (2) Male JIC - Barrel

SLS-2581-04-04

SLS-2581-04-05

SLS-2581-04-06

SLS-2581-06-05

SLS-2581-06-06

SLS-2581-06-08

SLS-2581-08-08

SLS-2581-08-10

SLS-2581-12-12

SLS-2581-16-16

SLS-2581-20-20

SLS-2581-24-24

SLS-2581-32-32

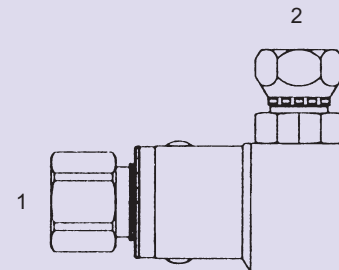

SLS-2583 - 90°

- (1) Fem. Pipe - Stem
- (2) Fem. JIC Swivel - Barrel

SLS-2583-04-04

SLS-2583-06-04

SLS-2583-06-06

SLS-2583-08-08

STEEL LIVE SWIVELS

Styles may vary from picture

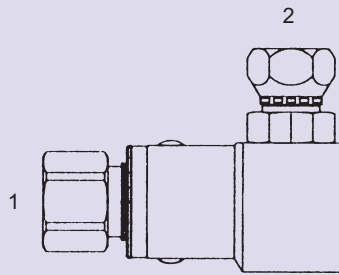

SLS-2583-4K - 90°

4000 PSI

- (1) Fem. Pipe - Stem
- (2) Fem. JIC Swivel - Barrel

- SLS-2583-4K-08-10
- SLS-2583-4K-12-12
- SLS-2583-4K-16-16
- SLS-2583-4K-20-20
- SLS-2583-4K-24-24

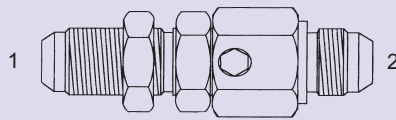

SLS-2710 - Str.

- (1) Male JIC Bulkhead - Stem
- (2) Male JIC - Barrel

- SLS-2710-08-08
- SLS-2710-10-10
- SLS-2710-12-12
- SLS-2710-16-16

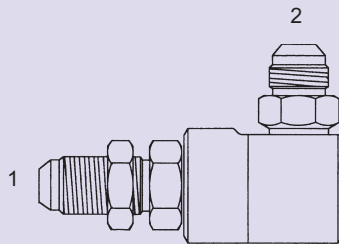

SLS-2711 - 90°

- (1) Male JIC Bulkhead - Stem
- (2) Male JIC - Barrel

- SLS-2711-08-08
- SLS-2711-12-12
- SLS-2711-16-16
- SLS-2711-20-20

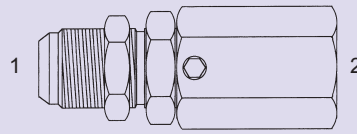

SLS-2712 - Str.

- (1) Male JIC Bulkhead - Stem
- (2) Fem. JIC - Barrel

- SLS-2712-08-08
- SLS-2712-10-10
- SLS-2712-12-12
- SLS-2712-16-16
- SLS-2712-20-20

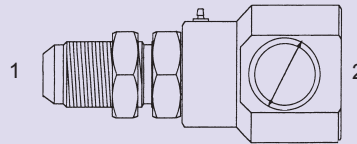

SLS-2715-SB - 90°

- (1) Male JIC Bulkhead - Stem
- (2) Fem. O-Ring - Barrel
(Short Body)

- SLS-2715-SB-08-08
- SLS-2715-SB-10-08
- SLS-2715-SB-12-12
- SLS-2715-SB-16-16
- SLS-2715-SB-20-20

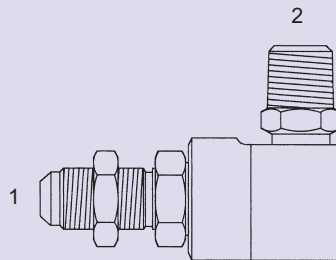

SLS-2717 - 90°

- (1) Male JIC Bulkhead - Stem
- (2) Male Pipe - Barrel

- SLS-2717-08-06
- SLS-2717-08-08
- SLS-2717-10-08
- SLS-2717-12-12
- SLS-2717-16-16
- SLS-2717-20-20

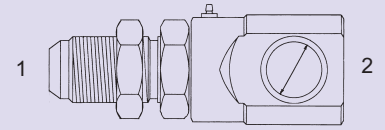

SLS-2718-SB - 90°

- (1) Male JIC Bulkhead - Stem
- (2) Fem. Pipe - Barrel
(Short Body)

- SLS-2718-SB-08-06
- SLS-2718-SB-08-08
- SLS-2718-SB-10-06
- SLS-2718-SB-10-08
- SLS-2718-SB-12-12
- SLS-2718-SB-16-16
- SLS-2718-SB-20-20

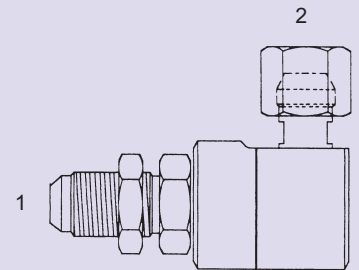

SLS-2719 - 90°

- (1) Male JIC Bulkhead - Stem
- (2) Fem. Pipe Swivel - Barrel

- SLS-2719-08-06
- SLS-2719-08-08
- SLS-2719-10-08
- SLS-2719-12-12
- SLS-2719-16-16
- SLS-2719-20-20

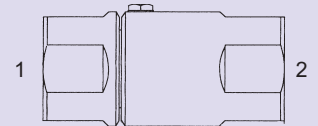

SLS-5000 - Str.

- (1) Fem. Pipe - Stem
- (2) Fem. Pipe - Barrel

- SLS-5000-02-02
- SLS-5000-04-04
- SLS-5000-04-06
- SLS-5000-06-06
- SLS-5000-08-08
- SLS-5000-12-08
- SLS-5000-12-12
- SLS-5000-16-16
- SLS-5000-20-20
- SLS-5000-24-24
- SLS-5000-32-32
- SLS-5000-40-40

STEEL LIVE SWIVELS

Styles may vary from picture

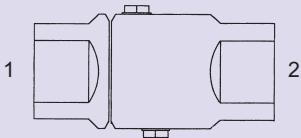

SLS-5000-HP - Str.
High Pressure - 10,000 PSI
(1) Fem. Pipe - Stem
(2) Fem. Pipe - Barrel

SLS-5000-HP-08-08

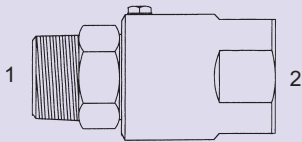

SLS-5405 - Str.
(1) Male Pipe - Stem
(2) Fem. Pipe - Barrel

SLS-5405-02-02
SLS-5405-04-04
SLS-5405-04-06
SLS-5405-06-04
SLS-5405-06-06
SLS-5405-08-08
SLS-5405-08-12
SLS-5405-12-08
SLS-5405-12-12
SLS-5405-16-16
SLS-5405-20-20
SLS-5405-24-24
SLS-5405-32-32

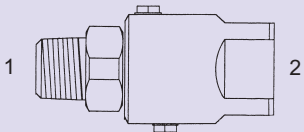

SLS-5405-HP - Str.
High Pressure - 10,000 PSI
(1) Male Pipe - Stem
(2) Fem. Pipe - Barrel

SLS-5405-HP-08-08

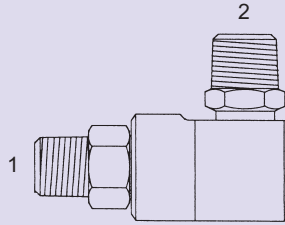

SLS-5500 - 90°
(1) Male Pipe - Stem
(2) Male Pipe - Barrel

SLS-5500-04-04
SLS-5500-04-06
SLS-5500-06-04
SLS-5500-06-06
SLS-5500-08-08
SLS-5500-08-06
SLS-5500-12-12
SLS-5500-16-16
SLS-5500-20-20
SLS-5500-24-24
SLS-5500-32-32

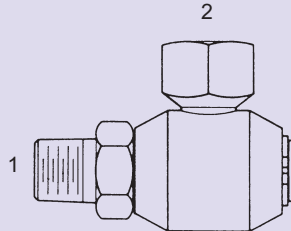

SLS-5502 - 90°
(1) Male Pipe - Stem
(2) Fem. Pipe - Barrel

SLS-5502-04-04
SLS-5502-04-06
SLS-5502-06-04
SLS-5502-06-06
SLS-5502-08-08
SLS-5502-12-12
SLS-5502-16-16
SLS-5502-20-20
SLS-5502-24-24
SLS-5502-32-32

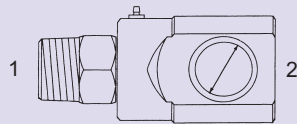

SLS-5502-SB - 90°
(1) Male Pipe - Stem
(2) Fem. Pipe - Barrel
(Short Body)

SLS-5502-SB-02-02
SLS-5502-SB-04-04
SLS-5502-SB-06-06
SLS-5502-SB-08-08
SLS-5502-SB-12-12
SLS-5502-SB-16-16
SLS-5502-SB-20-20
SLS-5502-SB-24-24
SLS-5502-SB-32-32

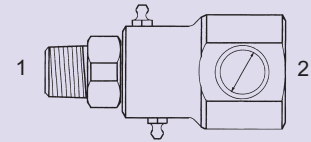

SLS-5502-SB-HP - 90°
High Pressure - 10,000 PSI
(1) Male Pipe - Stem
(2) Fem. Pipe - Barrel
(Short Body)

SLS-5502-SB-HP-08-08

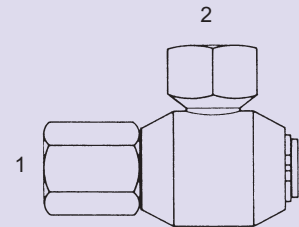

SLS-5504 - 90°
(1) Fem. Pipe - Stem
(2) Fem. Pipe - Barrel

SLS-5504-04-04
SLS-5504-04-06
SLS-5504-06-04
SLS-5504-06-06
SLS-5504-08-08
SLS-5504-12-12
SLS-5504-16-16
SLS-5504-20-20
SLS-5504-24-24
SLS-5504-32-32

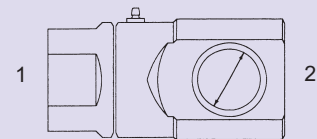

SLS-5504-SB - 90°
(1) Fem. Pipe - Stem
(2) Fem. Pipe - Barrel
(Short Body)

SLS-5504-SB-02-02
SLS-5504-SB-04-04
SLS-5504-SB-06-06
SLS-5504-SB-08-08
SLS-5504-SB-12-12
SLS-5504-SB-16-16
SLS-5504-SB-20-20
SLS-5504-SB-24-24
SLS-5504-SB-32-32

STEEL LIVE SWIVELS

Styles may vary from picture

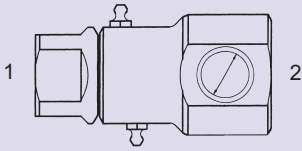

SLS-5504-SB-HP - 90°

High Pressure - 10,000 PSI

- (1) Fem. Pipe - Stem
- (2) Fem. Pipe - Barrel
(Short Body)

SLS-5504-SB-HP-08-08

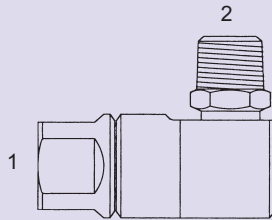

SLS-5587 - 90°

- (1) Fem. Pipe - Stem
- (2) Male Pipe - Barrel

- SLS-5587-04-04
- SLS-5587-04-06
- SLS-5587-06-04
- SLS-5587-06-06
- SLS-5587-06-08
- SLS-5587-08-06
- SLS-5587-08-08
- SLS-5587-12-12
- SLS-5587-16-16
- SLS-5587-20-20
- SLS-5587-24-24
- SLS-5587-32-32

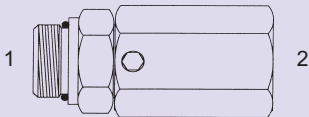

SLS-6402-O - Str.

- (1) Male O-Ring - Stem
- (2) Fem. JIC - Barrel

- SLS-6402-06-06-O
- SLS-6402-08-08-O
- SLS-6402-10-10-O
- SLS-6402-12-12-O
- SLS-6402-16-16-O
- SLS-6402-20-20-O
- SLS-6402-24-24-O

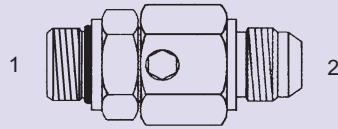

SLS-6441-O - Str.

- (1) Male O-Ring - Stem
- (2) Male JIC - Barrel

- SLS-6441-04-04-O
- SLS-6441-06-06-O
- SLS-6441-08-06-O
- SLS-6441-08-08-O
- SLS-6441-10-08-O
- SLS-6441-10-10-O
- SLS-6441-10-12-O
- SLS-6441-12-08-O
- SLS-6441-12-12-O
- SLS-6441-16-16-O
- SLS-6441-20-20-O
- SLS-6441-24-24-O
- SLS-6441-32-32-O

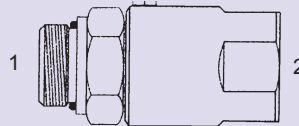

SLS-6448-O - Str.

- (1) Male O-Ring - Stem
- (2) Fem. Pipe - Barrel

- SLS-6448-06-04-O
- SLS-6448-08-06-O
- SLS-6448-08-08-O
- SLS-6448-10-08-O
- SLS-6448-16-16-O
- SLS-6448-20-20-O

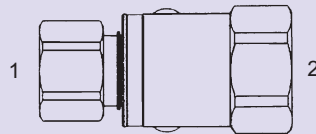

SLS-6455 - Str.

- (1) Fem. O-Ring - Stem
- (2) Fem. O-Ring - Barrel

- SLS-6455-04-04
- SLS-6455-08-08
- SLS-6455-16-16

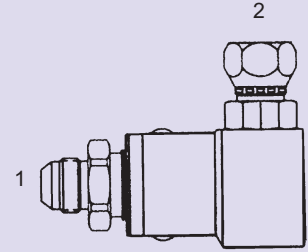

SLS-6513 - 90°

- (1) Male JIC Stem
- (2) Fem. JIC Swivel - Barrel

- SLS-6513-06-04
- SLS-6513-06-06
- SLS-6513-08-06
- SLS-6513-08-08
- SLS-6513-12-12
- SLS-6513-16-16

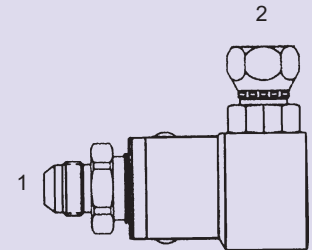

SLS-6513-4K - 90°

4000 PSI

- (1) Male JIC Stem
- (2) Fem. JIC Swivel - Barrel

- SLS-6513-4K-08-10
- SLS-6513-4K-10-10
- SLS-6513-4K-12-12
- SLS-6513-4K-16-16
- SLS-6513-4K-20-20
- SLS-6513-4K-24-24

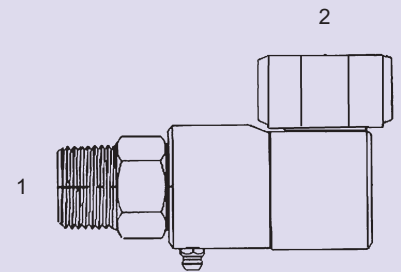

SLS-6573 - 90°

- (1) Male Pipe - Stem
- (2) Fem. 37° Swivel - Barrel

- SLS-6573-04-04
- SLS-6573-04-06
- SLS-6573-06-04
- SLS-6573-06-06
- SLS-6573-08-08

STEEL LIVE SWIVELS

Styles may vary from picture

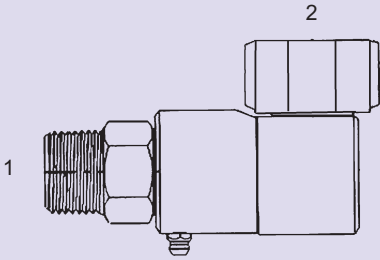

SLS-6573-4K - 90°
4000 PSI
(1) Male Pipe - Stem
(2) Fem. 37° Swivel - Barrel

SLS-6573-4K-08-10
SLS-6573-4K-12-12
SLS-6573-4K-16-16
SLS-6573-4K-20-20
SLS-6573-4K-24-24

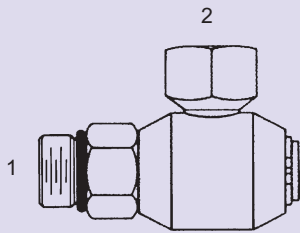

SLS-6805-O - 90°
(1) Male O-Ring - Stem
(2) Fem. Pipe - Barrel

SLS-6805-04-04-O
SLS-6805-04-06-O
SLS-6805-06-04-O
SLS-6805-06-06-O
SLS-6805-08-06-O
SLS-6805-08-08-O
SLS-6805-10-08-O
SLS-6805-12-12-O
SLS-6805-16-16-O
SLS-6805-20-20-O
SLS-6805-24-24-O
SLS-6805-32-32-O

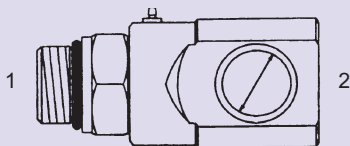

SLS-6805-SB-O - 90°
(1) Male O-Ring - Stem
(2) Fem. Pipe - Barrel
(Short Body)

SLS-6805-SB-04-04-O
SLS-6805-SB-06-04-O
SLS-6805-SB-06-06-O
SLS-6805-SB-08-06-O
SLS-6805-SB-08-08-O
SLS-6805-SB-12-12-O
SLS-6805-SB-16-16-O
SLS-6805-SB-20-20-O
SLS-6805-SB-24-24-O

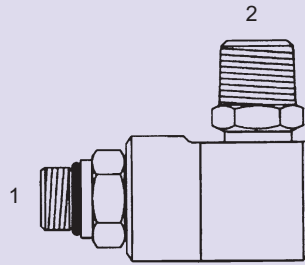

SLS-6806-O - 90°
(1) Male O-Ring - Stem
(2) Male Pipe - Barrel

SLS-6806-05-04-O
SLS-6806-05-06-O
SLS-6806-06-04-O
SLS-6806-06-06-O
SLS-6806-08-06-O
SLS-6806-08-08-O
SLS-6806-10-06-O
SLS-6806-10-08-O
SLS-6806-12-12-O
SLS-6806-16-16-O
SLS-6806-20-20-O
SLS-6806-24-24-O
SLS-6806-32-32-O

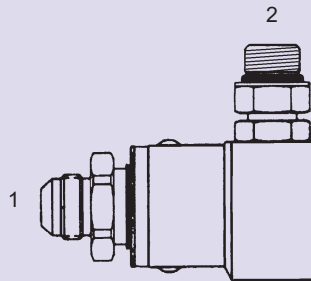

SLS-6814-4K-O - 90°
4000 PSI
(1) Male JIC - Stem
(2) Male O-Ring - Barrel

SLS-6814-4K-12-12-O

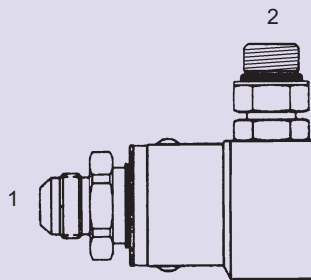

SLS-6814-5K-O - 90°
5000 PSI
(1) Male JIC - Stem
(2) Male O-Ring - Barrel

SLS-6814-5K-04-04-O
SLS-6814-5K-08-08-O

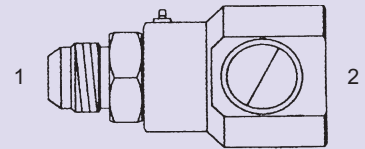

SLS-6815-SB - 90°
(1) Male JIC - Stem
(2) Fem. O-Ring - Barrel
(Short Body)

SLS-6815-SB-06-06
SLS-6815-SB-08-08
SLS-6815-SB-10-08
SLS-6815-SB-12-12
SLS-6815-SB-16-16
SLS-6815-SB-20-20

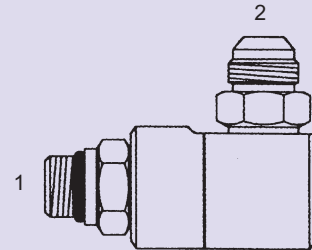

SLS-6841-O - 90°
(1) Male O-Ring - Stem
(2) Male JIC - Barrel

SLS-6841-04-04-O
SLS-6841-04-06-O
SLS-6841-05-04-O
SLS-6841-05-05-O
SLS-6841-05-06-O
SLS-6841-06-05-O
SLS-6841-06-06-O
SLS-6841-06-08-O
SLS-6841-08-05-O
SLS-6841-08-06-O
SLS-6841-08-08-O
SLS-6841-08-10-O
SLS-6841-10-06-O
SLS-6841-10-08-O
SLS-6841-10-10-O
SLS-6841-12-12-O
SLS-6841-16-16-O
SLS-6841-20-20-O
SLS-6841-24-24-O
SLS-6841-32-32-O

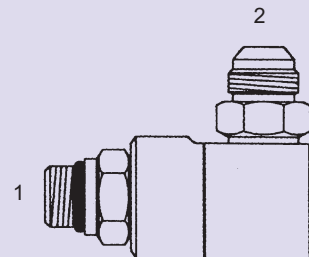

SLS-6841-4K-O - 90°
4000 PSI
(1) Male O-Ring - Stem
(2) Male JIC - Barrel

SLS-6841-4K-12-12-O

STEEL LIVE SWIVELS

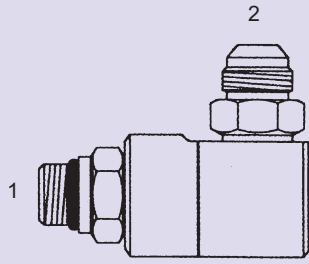

SLS-6841-5K-O - 90°

5000 PSI

- (1) Male O-Ring - Stem
- (2) Male JIC - Barrel

- SLS-6841-5K-04-04-O
- SLS-6841-5K-05-05-O
- SLS-6841-5K-05-06-O
- SLS-6841-5K-06-05-O
- SLS-6841-5K-06-06-O
- SLS-6841-5K-06-08-O
- SLS-6841-5K-08-06-O
- SLS-6841-5K-08-08-O
- SLS-6841-5K-08-10-O
- SLS-6841-5K-10-08-O
- SLS-6841-5K-10-10-O
- SLS-6841-5K-12-08-O

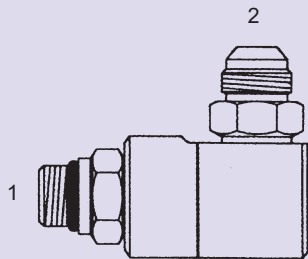

SLS-6841-LH-O - 90°

Large Hex

- (1) Male O-Ring - Stem
- (2) Male JIC - Barrel

SLS-6841-LH-08-08-O

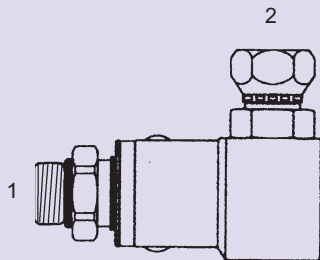

SLS-6843-O - 90°

- (1) Male O-Ring - Stem
- (2) Fem. JIC Swivel - Barrel

- SLS-6843-06-04-O
- SLS-6843-06-06-O
- SLS-6843-08-06-O
- SLS-6843-08-08-O

Styles may vary from picture

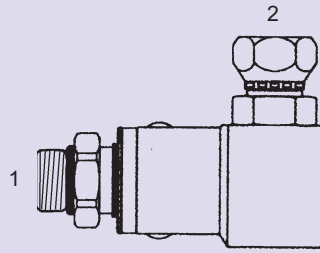

SLS-6843-4K-O - 90°

4000 PSI

- (1) Male O-Ring - Stem
- (2) Fem. JIC Swivel - Barrel

- SLS-6843-4K-10-10-O
- SLS-6843-4K-12-12-O
- SLS-6843-4K-16-16-O
- SLS-6843-4K-20-20-O
- SLS-6843-4K-24-24-O

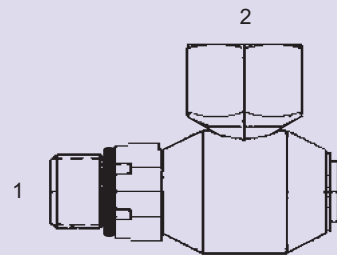

SLS-6845-O - 90°

- (1) Male O-Ring - Stem
- (2) Fem. O-Ring - Barrel

SLS-6845-08-08-O

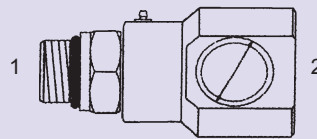

SLS-6845-SB-O - 90°

- (1) Male O-Ring - Stem
- (2) Fem. O-Ring - Barrel
(Short Body)

- SLS-6845-SB-04-04-O
- SLS-6845-SB-06-06-O
- SLS-6845-SB-08-08-O
- SLS-6845-SB-10-08-O
- SLS-6845-SB-12-12-O
- SLS-6845-SB-16-16-O
- SLS-6845-SB-20-20-O

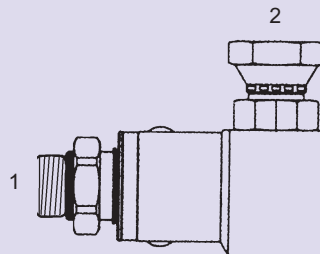

SLS-6849-O - 90°

- (1) Male O-Ring - Stem
- (2) Fem. Pipe Swivel - Barrel

- SLS-6849-12-12-O
- SLS-6849-16-16-O

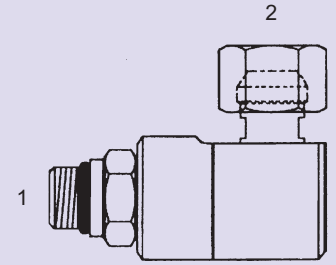

SLS-6901-O - 90°

- (1) Male O-Ring - Stem
- (2) Fem. Pipe Swivel - Barrel

- SLS-6901-04-04-O
- SLS-6901-04-06-O
- SLS-6901-05-04-O
- SLS-6901-06-04-O
- SLS-6901-06-06-O
- SLS-6901-08-06-O
- SLS-6901-08-08-O
- SLS-6901-10-08-O
- SLS-6901-12-12-O
- SLS-6901-16-16-O
- SLS-6901-20-20-O
- SLS-6901-24-24-O
- SLS-6901-32-32-O

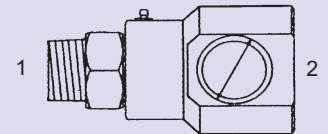

SLS-6975-SB - 90°

- (1) Male Pipe - Stem
- (2) Fem. O-Ring - Barrel
(Short Body)

- SLS-6975-SB-04-04
- SLS-6975-SB-04-06
- SLS-6975-SB-06-06
- SLS-6975-SB-06-08
- SLS-6975-SB-08-08
- SLS-6975-SB-12-12
- SLS-6975-SB-16-16
- SLS-6975-SB-20-20

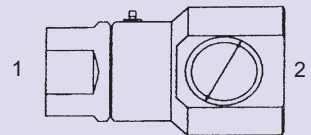

SLS-6985-SB - 90°

- (1) Fem. Pipe - Stem
- (2) Fem. O-Ring - Barrel

- SLS-6985-SB-04-06
- SLS-6985-SB-06-06
- SLS-6985-SB-06-08
- SLS-6985-SB-08-08
- SLS-6985-SB-12-12
- SLS-6985-SB-16-16
- SLS-6985-SB-20-20

STEEL LIVE SWIVELS - DUAL PLANE (90°)

Styles may vary from picture

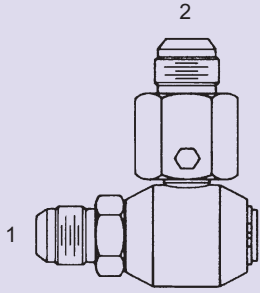

SLS-DP-2500 - 90°

- (1) Male JIC - Stem
- (2) Male JIC - Barrel

- SLS-DP-2500-05-06
- SLS-DP-2500-06-06
- SLS-DP-2500-08-06
- SLS-DP-2500-08-08
- SLS-DP-2500-10-10
- SLS-DP-2500-12-12
- SLS-DP-2500-16-16
- SLS-DP-2500-20-20
- SLS-DP-2500-24-24

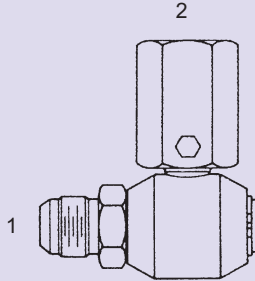

SLS-DP-2502 - 90°

- (1) Male JIC - Stem
- (2) Fem. Pipe - Barrel

- SLS-DP-2502-05-04
- SLS-DP-2502-05-06
- SLS-DP-2502-06-04
- SLS-DP-2502-06-06
- SLS-DP-2502-08-06
- SLS-DP-2502-10-08
- SLS-DP-2502-12-12
- SLS-DP-2502-16-16
- SLS-DP-2502-20-20
- SLS-DP-2502-24-24

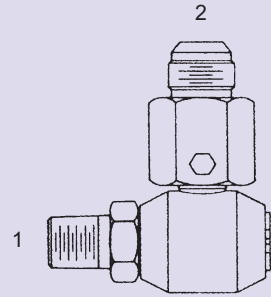

SLS-DP-2571-4K - 90°

- 4000 PSI
- (1) Male Pipe - Stem
- (2) Male JIC - Barrel

- SLS-DP-2571-4K-12-12
- SLS-DP-2571-4K-16-16
- SLS-DP-2571-4K-20-20
- SLS-DP-2571-4K-24-24

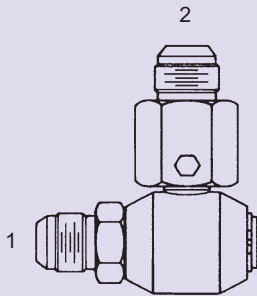

SLS-DP-2500-4K - 90°

- 4000 PSI
- (1) Male JIC - Stem
- (2) Male JIC - Barrel

- SLS-DP-2500-4K-12-12
- SLS-DP-2500-4K-16-16
- SLS-DP-2500-4K-20-20
- SLS-DP-2500-4K-24-24

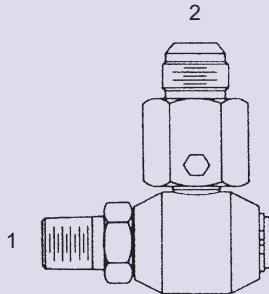

SLS-DP-2571 - 90°

- (1) Male Pipe - Stem
- (2) Male JIC - Barrel

- SLS-DP-2571-04-06
- SLS-DP-2571-06-08
- SLS-DP-2571-08-08
- SLS-DP-2571-08-10
- SLS-DP-2571-12-12
- SLS-DP-2571-16-16
- SLS-DP-2571-20-20
- SLS-DP-2571-24-24

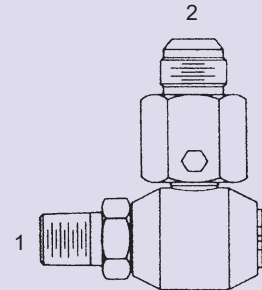

SLS-DP-2571-5K - 90°

- 5000 PSI
- (1) Male Pipe - Stem
- (2) Male JIC - Barrel

- SLS-DP-2571-5K-04-04
- SLS-DP-2571-5K-06-06
- SLS-DP-2571-5K-08-08
- SLS-DP-2571-5K-08-10

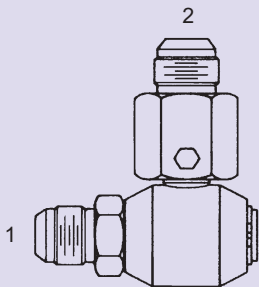

SLS-DP-2500-5K - 90°

- 5000 PSI
- (1) Male JIC - Stem
- (2) Male JIC - Barrel

- SLS-DP-2500-5K-04-04
- SLS-DP-2500-5K-06-06
- SLS-DP-2500-5K-08-08
- SLS-DP-2500-5K-10-10

STEEL LIVE SWIVELS - DUAL PLANE (90°)

Styles may vary from picture

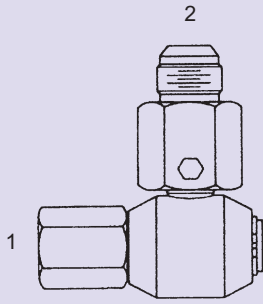

SLS-DP-2581 - 90°

- (1) Fem. Pipe - Stem
- (2) Male JIC - Barrel

- SLS-DP-2581-04-06
- SLS-DP-2581-06-06
- SLS-DP-2581-06-08
- SLS-DP-2581-08-10
- SLS-DP-2581-12-12
- SLS-DP-2581-16-16
- SLS-DP-2581-20-20
- SLS-DP-2581-24-24

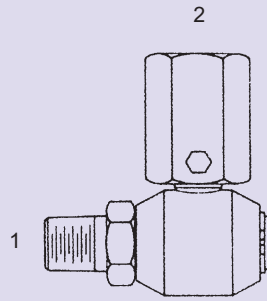

SLS-DP-5502-5K - 90°

- 5000 PSI
- (1) Male Pipe - Stem
- (2) Fem. Pipe - Barrel

- SLS-DP-5502-5K-04-04
- SLS-DP-5502-5K-06-06
- SLS-DP-5502-5K-08-08

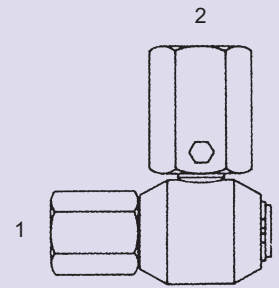

SLS-DP-5504-5K - 90°

- 5000 PSI
- (1) Fem. Pipe - Stem
- (2) Fem. Pipe - Barrel

- SLS-DP-5504-5K-04-04
- SLS-DP-5504-5K-06-06
- SLS-DP-5504-5K-08-08

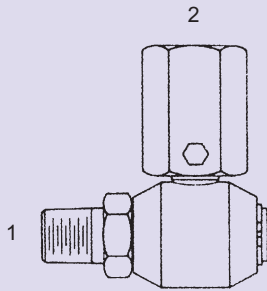

SLS-DP-5502 - 90°

- (1) Male Pipe - Stem
- (2) Fem. Pipe - Barrel

- SLS-DP-5502-04-04
- SLS-DP-5502-04-06
- SLS-DP-5502-06-06
- SLS-DP-5502-08-08
- SLS-DP-5502-12-12
- SLS-DP-5502-16-16
- SLS-DP-5502-20-20
- SLS-DP-5502-24-24

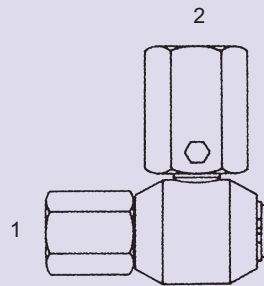

SLS-DP-5504 - 90°

- (1) Fem. Pipe - Stem
- (2) Fem. Pipe - Barrel

- SLS-DP-5504-04-04
- SLS-DP-5504-04-06
- SLS-DP-5504-06-04
- SLS-DP-5504-06-06
- SLS-DP-5504-08-08
- SLS-DP-5504-12-12
- SLS-DP-5504-16-16
- SLS-DP-5504-20-20
- SLS-DP-5504-24-24

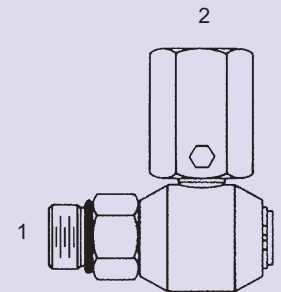

SLS-DP-6805-O - 90°

- (1) Male O-Ring - Stem
- (2) Fem. Pipe - Barrel

- SLS-DP-6805-06-04-O
- SLS-DP-6805-06-06-O
- SLS-DP-6805-08-06-O
- SLS-DP-6805-10-08-O
- SLS-DP-6805-12-12-O
- SLS-DP-6805-16-16-O
- SLS-DP-6805-20-20-O
- SLS-DP-6805-24-24-O

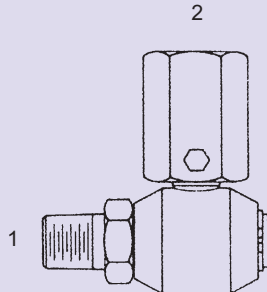

SLS-DP-5502-4K - 90°

- 4000 PSI
- (1) Male Pipe - Stem
- (2) Fem. Pipe - Barrel

- SLS-DP-5502-4K-12-12
- SLS-DP-5502-4K-16-16
- SLS-DP-5502-4K-20-20
- SLS-DP-5502-4K-24-24

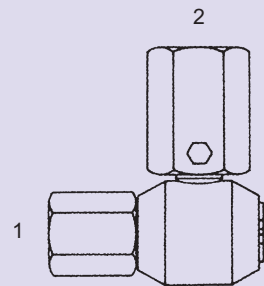

SLS-DP-5504-4K - 90°

- 4000 PSI
- (1) Fem. Pipe - Stem
- (2) Fem. Pipe - Barrel

- SLS-DP-5504-4K-12-12
- SLS-DP-5504-4K-16-16
- SLS-DP-5504-4K-20-20
- SLS-DP-5504-4K-24-24

STEEL LIVE SWIVELS - DUAL PLANE (90°)

Styles may vary from picture

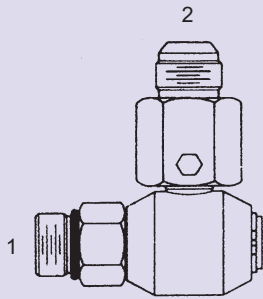

SLS-DP-6841-O - 90°

- (1) Male O-Ring - Stem
- (2) Male JIC - Barrel

- SLS-DP-6841-06-06-O
- SLS-DP-6841-08-06-O
- SLS-DP-6841-08-08-O
- SLS-DP-6841-10-10-O
- SLS-DP-6841-12-12-O
- SLS-DP-6841-16-16-O
- SLS-DP-6841-20-20-O
- SLS-DP-6841-24-24-O

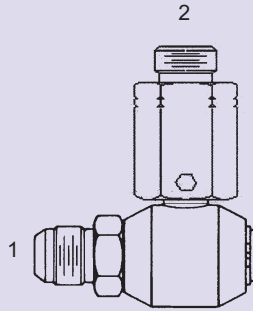

SLS-DP-OFS-6816 - 90°

- (1) Male JIC - Stem
- (2) Male O-Ring Face Seal - Barrel

- SLS-DP-OFS-6816-06-06
- SLS-DP-OFS-6816-08-08
- SLS-DP-OFS-6816-10-10
- SLS-DP-OFS-6816-12-12
- SLS-DP-OFS-6816-16-16
- SLS-DP-OFS-6816-20-20
- SLS-DP-OFS-6816-24-24

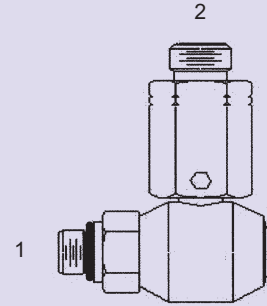

SLS-DP-OFS-6846-4K-O - 90°

4000 PSI

- (1) Male O-Ring - Stem
- (2) Male O-Ring Face Seal - Barrel

- SLS-DP-OFS-6846-4K-12-12
- SLS-DP-OFS-6846-4K-16-16
- SLS-DP-OFS-6846-4K-20-20
- SLS-DP-OFS-6846-4K-24-24

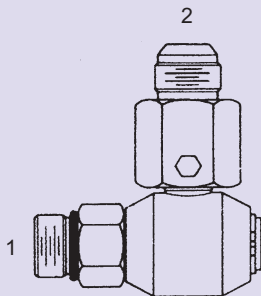

SLS-DP-6841-4K-O - 90°

4000 PSI

- (1) Male O-Ring - Stem
- (2) Male JIC - Barrel

- SLS-DP-6841-4K-12-12-O
- SLS-DP-6841-4K-16-16-O
- SLS-DP-6841-4K-20-20-O
- SLS-DP-6841-4K-24-24-O

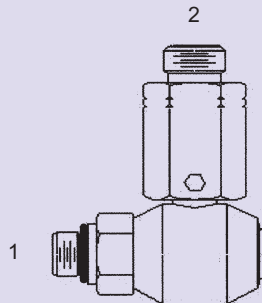

SLS-DP-OFS-6846-O - 90°

- (1) Male O-Ring - Stem
- (2) Male O-Ring Face Seal - Barrel

- SLS-DP-OFS-6846-06-06-O
- SLS-DP-OFS-6846-08-08-O
- SLS-DP-OFS-6846-10-10-O
- SLS-DP-OFS-6846-12-12-O
- SLS-DP-OFS-6846-16-16-O
- SLS-DP-OFS-6846-20-20-O
- SLS-DP-OFS-6846-24-24-O

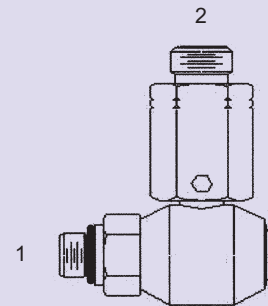

SLS-DP-OFS-6846-5K-O - 90°

5000 PSI

- (1) Male O-Ring - Stem
- (2) Male O-Ring Face Seal - Barrel

- SLS-DP-OFS-6846-5K-06-06
- SLS-DP-OFS-6846-5K-08-08
- SLS-DP-OFS-6846-5K-10-10

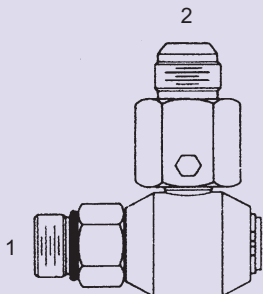

SLS-DP-6841-5K-O - 90°

5000 PSI

- (1) Male O-Ring - Stem
- (2) Male JIC - Barrel

- SLS-DP-6841-5K-04-04-O
- SLS-DP-6841-5K-06-06-O
- SLS-DP-6841-5K-08-08-O
- SLS-DP-6841-5K-10-10-O

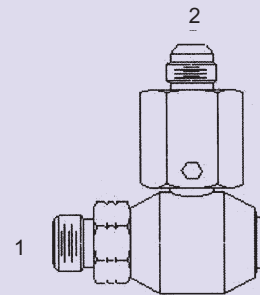

SLS-DP-OFS-6861 - 90°

- (1) Male O-Ring Face Seal - Stem
- (2) Male JIC - Barrel

- SLS-DP-OFS-6861-06-06
- SLS-DP-OFS-6861-08-08
- SLS-DP-OFS-6861-10-10
- SLS-DP-OFS-6861-12-12
- SLS-DP-OFS-6861-16-16
- SLS-DP-OFS-6861-20-20
- SLS-DP-OFS-6861-24-24

STEEL LIVE SWIVELS - DUAL PLANE (90°)

Styles may vary from picture

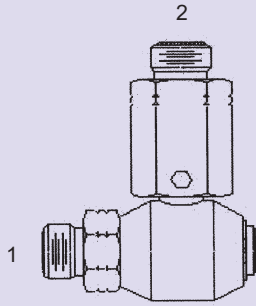

SLS-DP-OFS-6866 - 90°

- (1) Male O-Ring Face Seal - Stem
- (2) Male O-Ring Face Seal - Barrel

- SLS-DP-OFS-6866-06-06
- SLS-DP-OFS-6866-08-08
- SLS-DP-OFS-6866-10-10
- SLS-DP-OFS-6866-12-12
- SLS-DP-OFS-6866-16-16
- SLS-DP-OFS-6866-20-20
- SLS-DP-OFS-6866-24-24

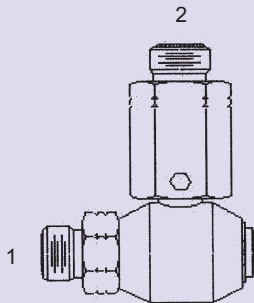

SLS-DP-OFS-6866-4K - 90°

- 4000 PSI
- (1) Male O-Ring Face Seal - Stem
- (2) Male O-Ring Face Seal - Barrel

- SLS-DP-OFS-6866-4K-12-12
- SLS-DP-OFS-6866-4K-16-16
- SLS-DP-OFS-6866-4K-20-20
- SLS-DP-OFS-6866-4K-24-24

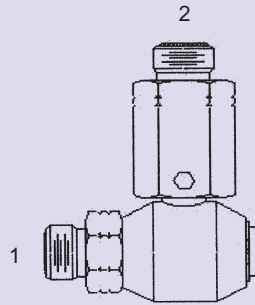

SLS-DP-OFS-6866-5K - 90°
5000 PSI

- (1) Male O-Ring Face Seal - Stem
- (2) Male O-Ring Face Seal - Barrel

- SLS-DP-OFS-6866-5K-06-06
- SLS-DP-OFS-6866-5K-10-10

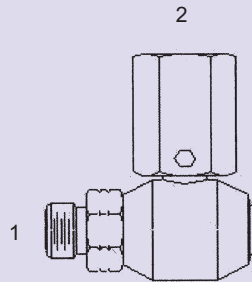

SLS-DP-OFS-6868 - 90°

- (1) Male O-Ring Face Seal - Stem
- (2) Female Pipe - Barrel

- SLS-DP-OFS-6868-06-04
- SLS-DP-OFS-6868-08-06
- SLS-DP-OFS-6868-10-08
- SLS-DP-OFS-6868-12-12
- SLS-DP-OFS-6868-16-16
- SLS-DP-OFS-6868-20-20
- SLS-DP-OFS-6868-24-24

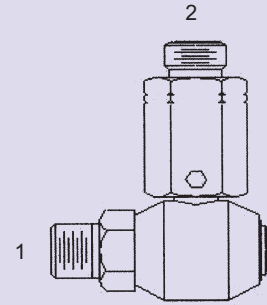

SLS-DP-OFS-6876 - 90°

- (1) Male Pipe - Stem
- (2) Male O-Ring Face Seal - Barrel

- SLS-DP-OFS-6876-04-06
- SLS-DP-OFS-6876-06-08
- SLS-DP-OFS-6876-08-10
- SLS-DP-OFS-6876-12-12
- SLS-DP-OFS-6876-16-16
- SLS-DP-OFS-6876-20-20
- SLS-DP-OFS-6876-24-24

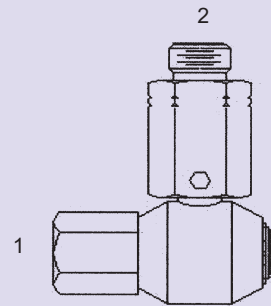

SLS-DP-OFS-6886 - 90°

- (1) Female Pipe - Stem
- (2) Male O-Ring Face Seal - Barrel

- SLS-DP-OFS-6886-04-06
- SLS-DP-OFS-6886-06-08
- SLS-DP-OFS-6886-08-10
- SLS-DP-OFS-6886-12-12
- SLS-DP-OFS-6886-16-16
- SLS-DP-OFS-6886-20-20
- SLS-DP-OFS-6886-24-24

STEEL LIVE SWIVELS - O-RING FACE SEAL

Styles may vary from picture

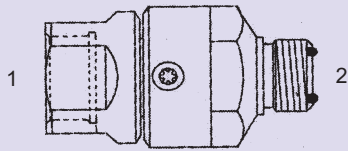

SLS-OFS-2406 - Str.
 (1) Fem. O-Ring Face Seal - Stem
 (2) Male O-Ring Face Seal - Barrel

- SLS-OFS-2406-06-06
- SLS-OFS-2406-08-08
- SLS-OFS-2406-10-10
- SLS-OFS-2406-12-12
- SLS-OFS-2406-16-16
- SLS-OFS-2406-20-20
- SLS-OFS-2406-24-24

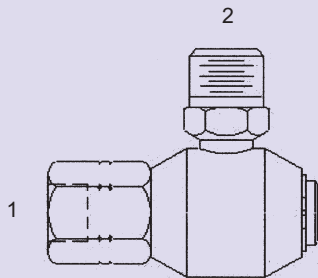

SLS-OFS-2507 - 90°
 (1) Fem. O-Ring Face Seal - Stem
 (2) Male Pipe - Barrel

- SLS-OFS-2507-04-04
- SLS-OFS-2507-06-04
- SLS-OFS-2507-06-06
- SLS-OFS-2507-08-04
- SLS-OFS-2507-08-06
- SLS-OFS-2507-08-08
- SLS-OFS-2507-10-08
- SLS-OFS-2507-12-12
- SLS-OFS-2507-16-16
- SLS-OFS-2507-20-20
- SLS-OFS-2507-24-24

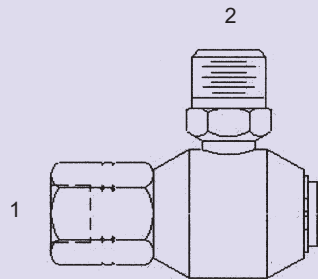

SLS-OFS-2509 - 90°
 (1) Fem. Pipe Swivel - Stem
 (2) Fem. O-Ring Face Seal - Barrel

- SLS-OFS-2509-04-04
- SLS-OFS-2509-06-04
- SLS-OFS-2509-06-06
- SLS-OFS-2509-08-04
- SLS-OFS-2509-08-06
- SLS-OFS-2509-08-08
- SLS-OFS-2509-10-08
- SLS-OFS-2509-12-12
- SLS-OFS-2509-16-16
- SLS-OFS-2509-20-20
- SLS-OFS-2509-24-24

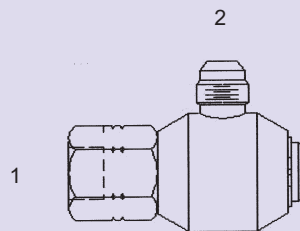

SLS-OFS-2510 - 90°
 (1) Fem. O-Ring Face Seal - Stem
 (2) Male JIC - Barrel

- SLS-OFS-2510-04-04
- SLS-OFS-2510-04-05
- SLS-OFS-2510-06-05
- SLS-OFS-2510-06-06
- SLS-OFS-2510-06-08
- SLS-OFS-2510-08-05
- SLS-OFS-2510-08-06
- SLS-OFS-2510-08-08
- SLS-OFS-2510-08-10
- SLS-OFS-2510-10-08
- SLS-OFS-2510-10-10
- SLS-OFS-2510-12-12
- SLS-OFS-2510-16-16
- SLS-OFS-2510-20-20
- SLS-OFS-2510-24-24

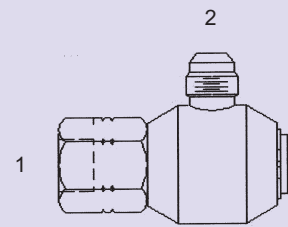

SLS-OFS-2510-5K - 90°
 5000 PSI
 (1) Fem. O-Ring Face Seal - Stem
 (2) Male JIC - Barrel

- SLS-OFS-2510-5K-04-05
- SLS-OFS-2510-5K-04-06
- SLS-OFS-2510-5K-06-05
- SLS-OFS-2510-5K-06-06
- SLS-OFS-2510-5K-06-08
- SLS-OFS-2510-5K-08-06
- SLS-OFS-2510-5K-08-08
- SLS-OFS-2510-5K-08-10
- SLS-OFS-2510-5K-10-08
- SLS-OFS-2510-5K-10-10

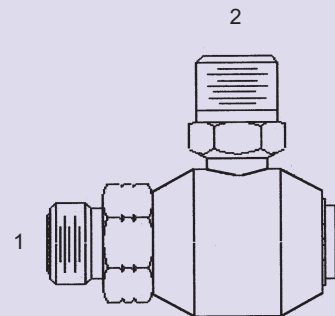

SLS-OFS-2567 - 90°
 (1) Male O-Ring Face Seal - Stem
 (2) Male Pipe - Barrel

- SLS-OFS-2567-06-04
- SLS-OFS-2567-06-06
- SLS-OFS-2567-08-04
- SLS-OFS-2567-08-06
- SLS-OFS-2567-08-08
- SLS-OFS-2567-10-08
- SLS-OFS-2567-12-12
- SLS-OFS-2567-16-16
- SLS-OFS-2567-20-20
- SLS-OFS-2567-24-24

STEEL LIVE SWIVELS - O-RING FACE SEAL

Styles may vary from picture

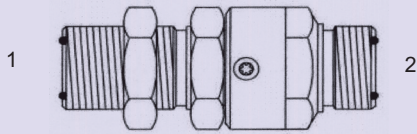

SLS-OFS-2700-LN - Str.

- (1) Male O-Ring Face Seal Bulkhead w/Locknut - Stem
- (2) Male O-Ring Face Seal - Barrel

SLS-OFS-2700-LN-06-06
 SLS-OFS-2700-LN-08-08
 SLS-OFS-2700-LN-10-10
 SLS-OFS-2700-LN-12-12
 SLS-OFS-2700-LN-16-16
 SLS-OFS-2700-LN-20-20

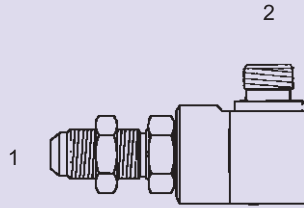

SLS-OFS-2716-LN-4K - 90°

- 4000 PSI
- (1) Male JIC - Stem
- (2) O-Ring Face Seal - Barrel

SLS-OFS-2716-LN-4K-12-12
 SLS-OFS-2716-LN-4K-16-16
 SLS-OFS-2716-LN-4K-20-20

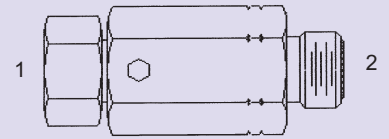

SLS-OFS-6426 - Str.

- (1) Fem. JIC - Stem
- (2) Male O-Ring Face Seal - Barrel

SLS-OFS-6426-06-06
 SLS-OFS-6426-08-08
 SLS-OFS-6426-10-10
 SLS-OFS-6426-12-12
 SLS-OFS-6426-16-16
 SLS-OFS-6426-20-20
 SLS-OFS-6426-24-24

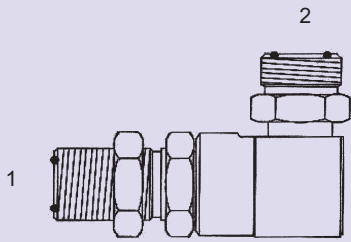

SLS-OFS-2701-LN-4K - 90°

- 4000 PSI
- (1) Male O-Ring Face Seal Bulkhead w/ Locknut - Stem
- (2) Male O-Ring Face Seal - Barrel

SLS-OFS-2701-LN-4K-12-12
 SLS-OFS-2701-LN-4K-16-16
 SLS-OFS-2701-LN-4K-20-20

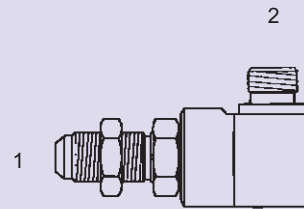

SLS-OFS-2716-LN-5K - 90°

- 5000 PSI
- (1) Male JIC - Stem
- (2) O-Ring Face Seal - Barrel

SLS-OFS-2716-LN-5K-08-06
 SLS-OFS-2716-LN-5K-08-08
 SLS-OFS-2716-LN-5K-08-10
 SLS-OFS-2716-LN-5K-10-06
 SLS-OFS-2716-LN-5K-10-08
 SLS-OFS-2716-LN-5K-10-10

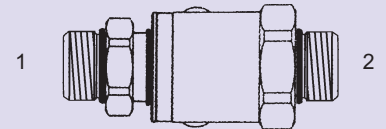

SLS-OFS-6446-O - Str.

- (1) Male O-Ring - Stem
- (2) Male O-Ring Face Seal - Barrel

SLS-OFS-6446-06-06-O
 SLS-OFS-6446-08-06-O
 SLS-OFS-6446-08-10-O
 SLS-OFS-6446-10-10-O
 SLS-OFS-6446-12-12-O
 SLS-OFS-6446-16-16-O
 SLS-OFS-6446-20-20-O
 SLS-OFS-6446-24-24-O

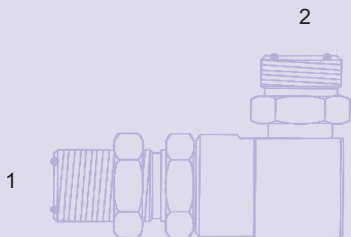

SLS-OFS-2701-LN-5K - 90°

- 5000 PSI
- (1) Male O-Ring Face Seal Bulkhead w/ Locknut - Stem
- (2) Male O-Ring Face Seal - Barrel

SLS-OFS-2701-LN-5K-06-06
 SLS-OFS-2701-LN-5K-08-08
 SLS-OFS-2701-LN-5K-10-10

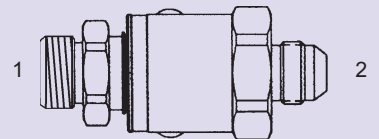

SLS-OFS-6461 - Str.

- (1) Male O-Ring Face Seal - Stem
- (2) Male JIC - Barrel

SLS-OFS-6461-06-06
 SLS-OFS-6461-08-08
 SLS-OFS-6461-12-12
 SLS-OFS-6461-16-16
 SLS-OFS-6461-20-20
 SLS-OFS-6461-24-24

STEEL LIVE SWIVELS - O-RING FACE SEAL

Styles may vary from picture

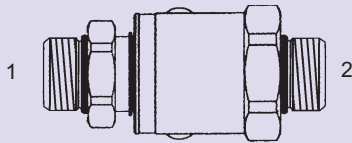

SLS-OFS-6466 - Str.

- (1) Male O-Ring Face Seal - Stem
- (2) Male O-Ring Face Seal - Barrel

- SLS-OFS-6466-06-06
- SLS-OFS-6466-08-08
- SLS-OFS-6466-10-10
- SLS-OFS-6466-12-12
- SLS-OFS-6466-16-16
- SLS-OFS-6466-20-20
- SLS-OFS-6466-24-24

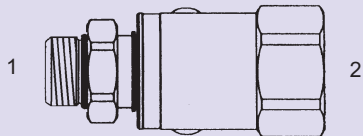

SLS-OFS-6468 - Str.

- (1) Male O-Ring Face Seal - Stem
- (2) Fem. Pipe - Barrel

- SLS-OFS-6468-06-04
- SLS-OFS-6468-08-06
- SLS-OFS-6468-10-08
- SLS-OFS-6468-12-12
- SLS-OFS-6468-16-16
- SLS-OFS-6468-20-20
- SLS-OFS-6468-24-24

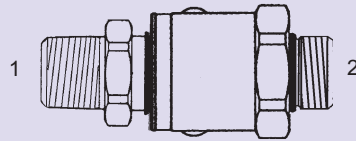

SLS-OFS-6476 - Str.

- (1) Male Pipe - Stem
- (2) Male O-Ring Face Seal - Barrel

- SLS-OFS-6476-04-06
- SLS-OFS-6476-06-08
- SLS-OFS-6476-12-12
- SLS-OFS-6476-16-16
- SLS-OFS-6476-20-20
- SLS-OFS-6476-24-24

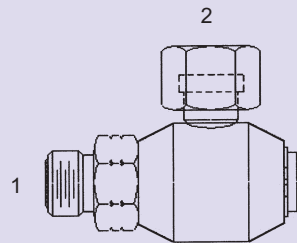

SLS-OFS-6500 - 90°

- (1) Male O-Ring Face Seal - Stem
- (2) Fem. O-Ring Face Seal Swivel - Barrel

- SLS-OFS-6500-06-06
- SLS-OFS-6500-08-06
- SLS-OFS-6500-08-08
- SLS-OFS-6500-08-10
- SLS-OFS-6500-10-08
- SLS-OFS-6500-10-10
- SLS-OFS-6500-12-12
- SLS-OFS-6500-16-16
- SLS-OFS-6500-20-20
- SLS-OFS-6500-24-24

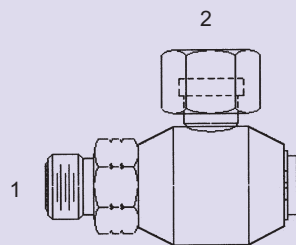

SLS-OFS-6500-5K - 90°

5000 PSI

- (1) Male O-Ring Face Seal - Stem
- (2) Fem. O-Ring Face Seal Swivel - Barrel

- SLS-OFS-6500-5K-04-06
- SLS-OFS-6500-5K-06-06
- SLS-OFS-6500-5K-06-08
- SLS-OFS-6500-5K-08-06
- SLS-OFS-6500-5K-08-08
- SLS-OFS-6500-5K-08-10
- SLS-OFS-6500-5K-10-08
- SLS-OFS-6500-5K-10-10

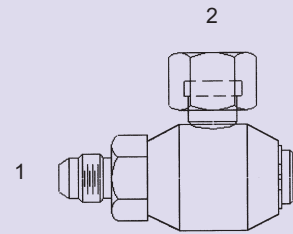

SLS-OFS-6510 - 90°

- (1) Male JIC - Stem
- (2) Fem. O-Ring Face Seal Swivel - Barrel

- SLS-OFS-6510-05-06
- SLS-OFS-6510-06-06
- SLS-OFS-6510-08-06
- SLS-OFS-6510-08-08
- SLS-OFS-6510-08-10
- SLS-OFS-6510-10-08
- SLS-OFS-6510-10-10
- SLS-OFS-6510-12-12
- SLS-OFS-6510-16-16
- SLS-OFS-6510-20-20
- SLS-OFS-6510-24-24

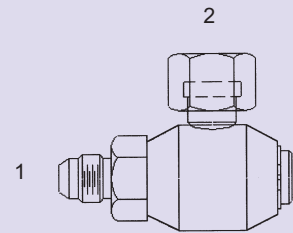

SLS-OFS-6510-5K - 90°

5000 PSI

- (1) Male JIC - Stem
- (2) Fem. O-Ring Face Seal Swivel - Barrel

- SLS-OFS-6510-5K-05-06
- SLS-OFS-6510-5K-06-06
- SLS-OFS-6510-5K-06-08
- SLS-OFS-6510-5K-08-06
- SLS-OFS-6510-5K-08-08
- SLS-OFS-6510-5K-08-10
- SLS-OFS-6510-5K-10-08
- SLS-OFS-6510-5K-10-10

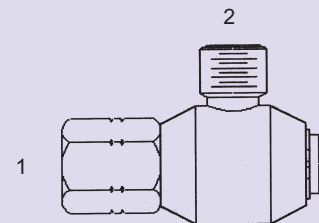

SLS-OFS-6560 - 90°

- (1) Fem. O-Ring Face Seal - Stem
- (2) Male O-Ring Face Seal - Barrel

- SLS-OFS-6560-04-04
- SLS-OFS-6560-06-06
- SLS-OFS-6560-08-08
- SLS-OFS-6560-10-10
- SLS-OFS-6560-12-12
- SLS-OFS-6560-16-16
- SLS-OFS-6560-20-20
- SLS-OFS-6560-24-24

STEEL LIVE SWIVELS - O-RING FACE SEAL

Styles may vary from picture

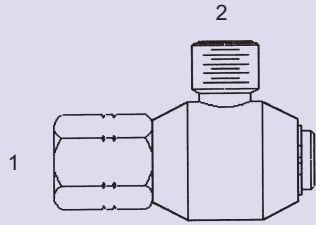

SLS-OFS-6560-4K - 90°

4000 PSI

- (1) Fem. O-Ring Face Seal - Stem
- (2) Male O-Ring Face Seal - Barrel

SLS-OFS-6560-4K-12-12
 SLS-OFS-6560-4K-16-16
 SLS-OFS-6560-4K-20-20
 SLS-OFS-6560-4K-24-24

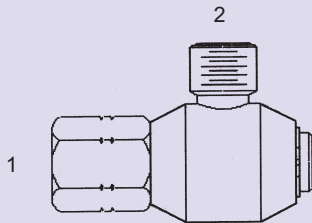

SLS-OFS-6560-5K - 90°

5000 PSI

- (1) Fem. O-Ring Face Seal - Stem
- (2) Male O-Ring Face Seal - Barrel

SLS-OFS-6560-5K-04-04
 SLS-OFS-6560-5K-04-06
 SLS-OFS-6560-5K-06-04
 SLS-OFS-6560-5K-06-06
 SLS-OFS-6560-5K-06-08
 SLS-OFS-6560-5K-08-06
 SLS-OFS-6560-5K-08-08
 SLS-OFS-6560-5K-08-10
 SLS-OFS-6560-5K-10-08
 SLS-OFS-6560-5K-10-10

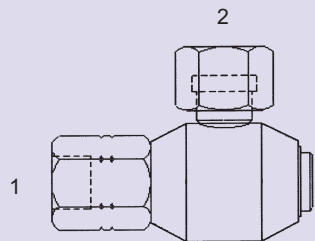

SLS-OFS-6565 - 90°

- (1) Fem. O-Ring Face Seal - Stem
- (2) Male O-Ring Face Seal Swivel - Barrel

SLS-OFS-6565-06-06
 SLS-OFS-6565-08-06
 SLS-OFS-6565-08-08
 SLS-OFS-6565-08-10
 SLS-OFS-6565-10-10
 SLS-OFS-6565-12-12
 SLS-OFS-6565-16-16
 SLS-OFS-6565-20-20
 SLS-OFS-6565-24-24

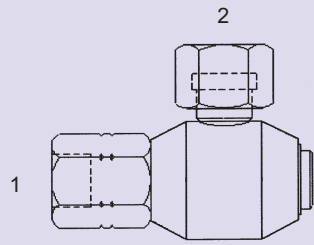

SLS-OFS-6565-5K - 90°

5000 PSI

- (1) Fem. O-Ring Face Seal - Stem
- (2) Male O-Ring Face Seal Swivel - Barrel

SLS-OFS-6565-5K-04-06
 SLS-OFS-6565-5K-06-06
 SLS-OFS-6565-5K-06-08
 SLS-OFS-6565-5K-08-06
 SLS-OFS-6565-5K-08-08
 SLS-OFS-6565-5K-08-10
 SLS-OFS-6565-5K-10-08
 SLS-OFS-6565-5K-10-10

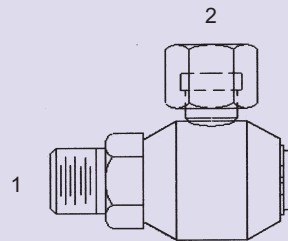

SLS-OFS-6570 - 90°

- (1) Male Pipe - Stem
- (2) Fem. O-Ring Face Seal Swivel - Barrel

SLS-OFS-6570-04-04
 SLS-OFS-6570-04-06
 SLS-OFS-6570-06-06
 SLS-OFS-6570-08-08
 SLS-OFS-6570-08-10
 SLS-OFS-6570-12-12
 SLS-OFS-6570-16-16
 SLS-OFS-6570-20-20
 SLS-OFS-6570-24-24

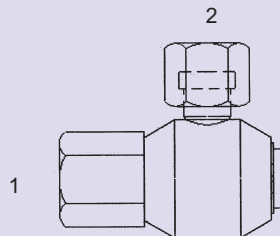

SLS-OFS-6580 - 90°

- (1) Fem. Pipe - Stem
- (2) Fem. O-Ring Face Seal Swivel - Barrel

SLS-OFS-6580-04-06
 SLS-OFS-6580-06-06
 SLS-OFS-6580-08-08
 SLS-OFS-6580-08-10
 SLS-OFS-6580-12-12
 SLS-OFS-6580-16-16
 SLS-OFS-6580-20-20
 SLS-OFS-6580-24-24

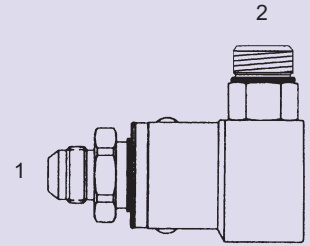

SLS-OFS-6816 - 90°

- (1) Male JIC - Stem
- (2) Male O-Ring Face Seal - Barrel

SLS-OFS-6816-06-06
 SLS-OFS-6816-08-08
 SLS-OFS-6816-10-10
 SLS-OFS-6816-12-12
 SLS-OFS-6816-16-16
 SLS-OFS-6816-20-20
 SLS-OFS-6816-24-24

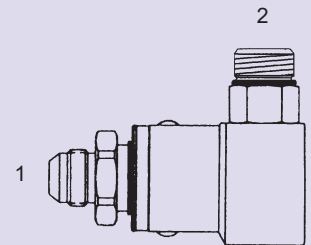

SLS-OFS-6816-4K - 90°

4000 PSI

- (1) Male JIC - Stem
- (2) Male O-Ring Face Seal - Barrel

SLS-OFS-6816-4K-12-12
 SLS-OFS-6816-4K-16-16
 SLS-OFS-6816-4K-20-20
 SLS-OFS-6816-4K-24-24

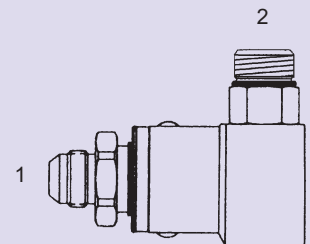

SLS-OFS-6816-5K - 90°

5000 PSI

- (1) Male JIC - Stem
- (2) Male O-Ring Face Seal - Barrel

SLS-OFS-6816-5K-05-04
 SLS-OFS-6816-5K-05-06
 SLS-OFS-6816-5K-06-04
 SLS-OFS-6816-5K-06-06
 SLS-OFS-6816-5K-06-08
 SLS-OFS-6816-5K-08-06
 SLS-OFS-6816-5K-08-08
 SLS-OFS-6816-5K-08-10
 SLS-OFS-6816-5K-10-08
 SLS-OFS-6816-5K-10-10

STEEL LIVE SWIVELS - O-RING FACE SEAL

Styles may vary from picture

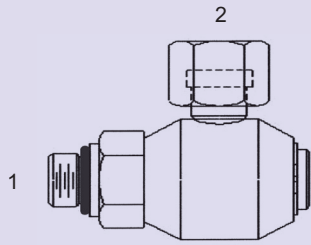

SLS-OFS-6840-O - 90°
 (1) Male O-Ring - Stem
 (2) Fem. O-Ring Face Seal Swivel - Barrel

- SLS-OFS-6840-04-06-O
- SLS-OFS-6840-05-06-O
- SLS-OFS-6840-06-06-O
- SLS-OFS-6840-08-06-O
- SLS-OFS-6840-08-08-O
- SLS-OFS-6840-08-10-O
- SLS-OFS-6840-10-08-O
- SLS-OFS-6840-10-10-O
- SLS-OFS-6840-12-08-O
- SLS-OFS-6840-12-10-O
- SLS-OFS-6840-12-12-O
- SLS-OFS-6840-16-16-O
- SLS-OFS-6840-20-20-O
- SLS-OFS-6840-24-24-O

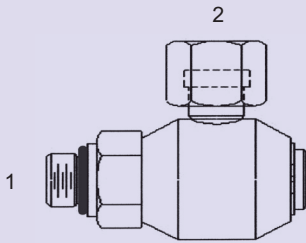

SLS-OFS-6840-5K-O - 90°
 5000 PSI
 (1) Male O-Ring - Stem
 (2) Fem. O-Ring Face Seal Swivel - Barrel

- SLS-OFS-6840-5K-05-06-O
- SLS-OFS-6840-5K-06-06-O
- SLS-OFS-6840-5K-06-08-O
- SLS-OFS-6840-5K-08-06-O
- SLS-OFS-6840-5K-08-08-O
- SLS-OFS-6840-5K-08-10-O
- SLS-OFS-6840-5K-10-08-O
- SLS-OFS-6840-5K-10-10-O

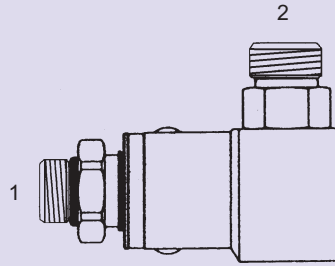

SLS-OFS-6846-O - 90°
 (1) Male O-Ring - Stem
 (2) Male O-Ring Face Seal - Barrel

- SLS-OFS-6846-04-04-O
- SLS-OFS-6846-04-06-O
- SLS-OFS-6846-05-08-O
- SLS-OFS-6846-06-04-O
- SLS-OFS-6846-06-06-O
- SLS-OFS-6846-06-08-O
- SLS-OFS-6846-08-06-O
- SLS-OFS-6846-08-08-O
- SLS-OFS-6846-08-10-O
- SLS-OFS-6846-10-08-O
- SLS-OFS-6846-10-10-O
- SLS-OFS-6846-12-08-O
- SLS-OFS-6846-12-10-O
- SLS-OFS-6846-12-12-O
- SLS-OFS-6846-16-16-O
- SLS-OFS-6846-20-20-O
- SLS-OFS-6846-24-24-O

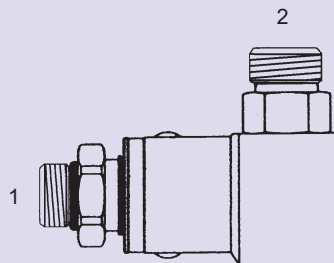

SLS-OFS-6846-4K-O - 90°
 4000 PSI
 (1) Male O-Ring - Stem
 (2) Male O-Ring Face Seal - Barrel

- SLS-OFS-6846-4K-12-12-O
- SLS-OFS-6846-4K-16-16-O
- SLS-OFS-6846-4K-20-20-O
- SLS-OFS-6846-4K-24-24-O

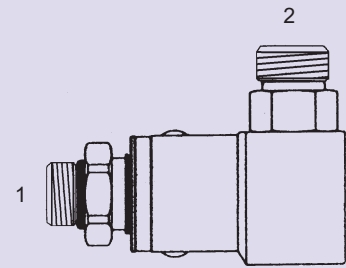

SLS-OFS-6846-5K-O - 90°
 5000 PSI
 (1) Male O-Ring - Stem
 (2) Male O-Ring Face Seal - Barrel

- SLS-OFS-6846-5K-05-04-O
- SLS-OFS-6846-5K-05-06-O
- SLS-OFS-6846-5K-06-04-O
- SLS-OFS-6846-5K-06-06-O
- SLS-OFS-6846-5K-06-08-O
- SLS-OFS-6846-5K-08-06-O
- SLS-OFS-6846-5K-08-08-O
- SLS-OFS-6846-5K-08-10-O
- SLS-OFS-6846-5K-10-08-O
- SLS-OFS-6846-5K-10-10-O

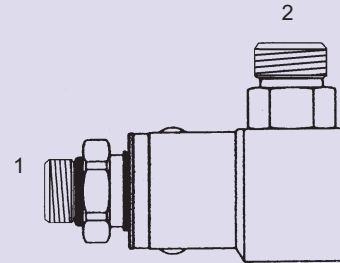

SLS-OFS-6846-LH - 90°
 5000 PSI
 Large Hex
 (1) Male O-Ring - Stem
 (2) Male O-Ring Face Seal - Barrel

- SLS-OFS-6846-LH-08-08-O

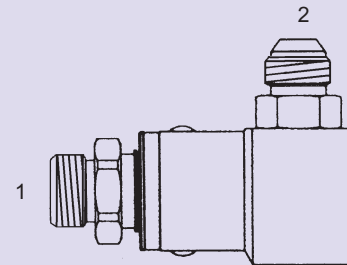

SLS-OFS-6861 - 90°
 (1) Male O-Ring Face Seal - Stem
 (2) Male JIC - Barrel

- SLS-OFS-6861-06-05
- SLS-OFS-6861-06-06
- SLS-OFS-6861-06-08
- SLS-OFS-6861-08-06
- SLS-OFS-6861-08-08
- SLS-OFS-6861-08-10
- SLS-OFS-6861-10-10
- SLS-OFS-6861-12-12
- SLS-OFS-6861-16-16
- SLS-OFS-6861-20-20
- SLS-OFS-6861-24-24

STEEL LIVE SWIVELS - O-RING FACE SEAL

Styles may vary from picture

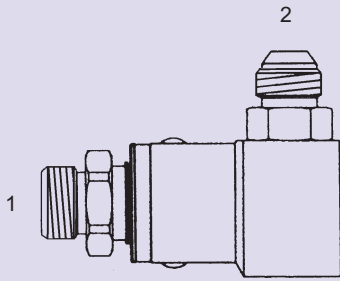

SLS-OFS-6861-5K - 90°

5000 PSI

- (1) Male O-Ring Face Seal - Stem
- (2) Male JIC - Barrel

- SLS-OFS-6861-5K-04-05
- SLS-OFS-6861-5K-04-06
- SLS-OFS-6861-5K-06-05
- SLS-OFS-6861-5K-06-06
- SLS-OFS-6861-5K-06-08
- SLS-OFS-6861-5K-08-06
- SLS-OFS-6861-5K-08-08
- SLS-OFS-6861-5K-08-10
- SLS-OFS-6861-5K-10-08
- SLS-OFS-6861-5K-10-10

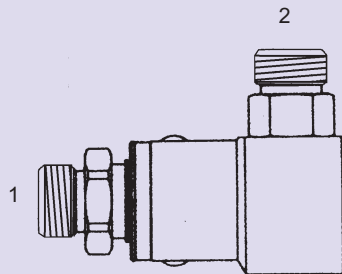

SLS-OFS-6866 - 90°

- (1) Male O-Ring Face Seal - Stem
- (2) Male O-Ring Face Seal - Barrel

- SLS-OFS-6866-04-04
- SLS-OFS-6866-06-06
- SLS-OFS-6866-06-08
- SLS-OFS-6866-08-06
- SLS-OFS-6866-08-08
- SLS-OFS-6866-08-10
- SLS-OFS-6866-10-10
- SLS-OFS-6866-12-12
- SLS-OFS-6866-16-16
- SLS-OFS-6866-20-20
- SLS-OFS-6866-24-24

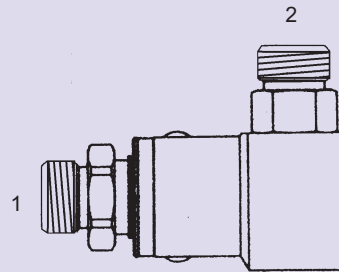

SLS-OFS-6866-4K - 90°

4000 PSI

- (1) Male O-Ring Face Seal - Stem
- (2) Male O-Ring Face Seal - Barrel

- SLS-OFS-6866-4K-12-12
- SLS-OFS-6866-4K-16-16
- SLS-OFS-6866-4K-20-20
- SLS-OFS-6866-4K-24-24

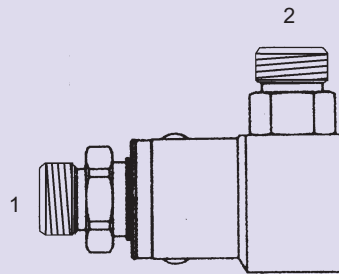

SLS-OFS-6866-5K - 90°

5000 PSI

- (1) Male O-Ring Face Seal - Stem
- (2) Male O-Ring Face Seal - Barrel

- SLS-OFS-6866-5K-04-04
- SLS-OFS-6866-5K-04-06
- SLS-OFS-6866-5K-06-04
- SLS-OFS-6866-5K-06-06
- SLS-OFS-6866-5K-06-08
- SLS-OFS-6866-5K-08-06
- SLS-OFS-6866-5K-08-08
- SLS-OFS-6866-5K-08-10
- SLS-OFS-6866-5K-10-08
- SLS-OFS-6866-5K-10-10

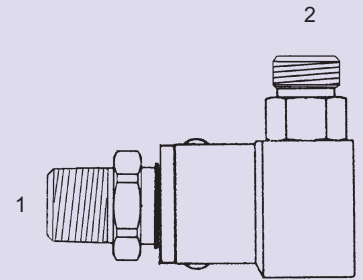

SLS-OFS-6876 - 90°

- (1) Male Pipe - Stem
- (2) Male O-Ring Face Seal - Barrel

- SLS-OFS-6876-04-04
- SLS-OFS-6876-04-06
- SLS-OFS-6876-06-06
- SLS-OFS-6876-06-08
- SLS-OFS-6876-08-08
- SLS-OFS-6876-08-10
- SLS-OFS-6876-12-12
- SLS-OFS-6876-16-16
- SLS-OFS-6876-20-20
- SLS-OFS-6876-24-24

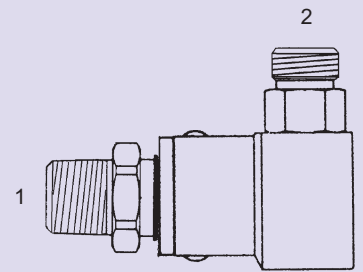

SLS-OFS-6876-4K - 90°

4000 PSI

- (1) Male Pipe - Stem
- (2) Male O-Ring Face Seal - Barrel

- SLS-OFS-6876-4K-12-12
- SLS-OFS-6876-4K-16-16
- SLS-OFS-6876-4K-20-20
- SLS-OFS-6876-4K-24-24

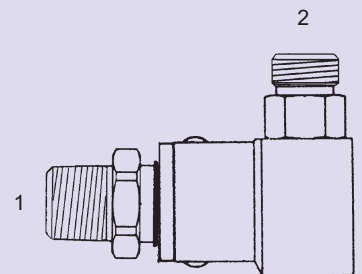

SLS-OFS-6876-5K - 90°

5000 PSI

- (1) Male Pipe - Stem
- (2) Male O-Ring Face Seal - Barrel

- SLS-OFS-6876-5K-04-04
- SLS-OFS-6876-5K-06-06
- SLS-OFS-6876-5K-06-08
- SLS-OFS-6876-5K-08-08
- SLS-OFS-6876-5K-08-10

STEEL LIVE SWIVELS - O-RING FACE SEAL

Styles may vary from picture

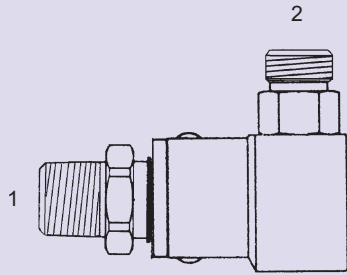

SLS-OFS-6876-5K-LH - 90°

5000 PSI
Large Hex

- (1) Male Pipe - Stem
- (2) Male O-Ring Face Seal - Barrel

SLS-OFS-6876-5K-LH-06-06

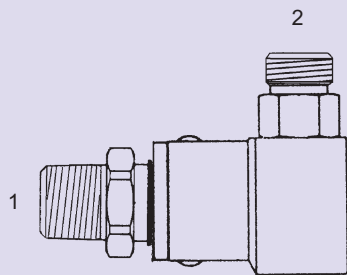

SLS-OFS-6876-LH - 90°

Large Hex

- (1) Male Pipe - Stem
- (2) Male O-Ring Face Seal - Barrel

SLS-OFS-6876-LH-06-06

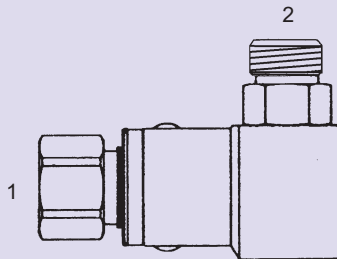

SLS-OFS-6886 - 90°

- (1) Fem. Pipe - Stem
- (2) Male O-Ring Face Seal - Barrel

SLS-OFS-6886-04-06
SLS-OFS-6886-06-06
SLS-OFS-6886-06-08
SLS-OFS-6886-08-08
SLS-OFS-6886-08-10
SLS-OFS-6886-12-12
SLS-OFS-6886-16-16
SLS-OFS-6886-20-20
SLS-OFS-6886-24-24

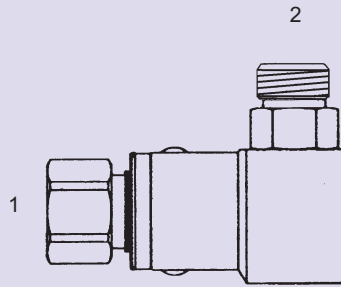

SLS-OFS-6886-4K - 90°

4000 PSI

- (1) Fem. Pipe - Stem
- (2) Male O-Ring Face Seal - Barrel

SLS-OFS-6886-4K-12-12
SLS-OFS-6886-4K-16-16
SLS-OFS-6886-4K-20-20
SLS-OFS-6886-4K-24-24

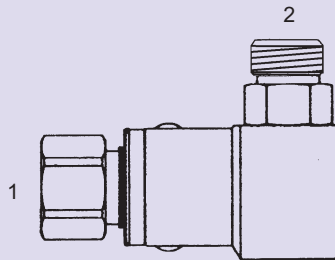

SLS-OFS-6886-5K - 90°

5000 PSI

- (1) Fem. Pipe - Stem
- (2) Male O-Ring Face Seal - Barrel

SLS-OFS-6886-5K-04-06
SLS-OFS-6886-5K-06-06
SLS-OFS-6886-5K-06-08
SLS-OFS-6886-5K-08-08
SLS-OFS-6886-5K-08-10

STEEL LIVE SWIVELS -PARALLEL PLANE (180° 3000 PSI)

Styles may vary from picture

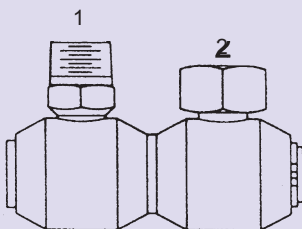

SLS-PP-1404

- (1) Male Pipe - Stem
- (2) Fem. Pipe Swivel - Barrel

- SLS-PP-1404-04-04
- SLS-PP-1404-04-06
- SLS-PP-1404-06-04
- SLS-PP-1404-06-06
- SLS-PP-1404-08-08
- SLS-PP-1404-12-12
- SLS-PP-1404-16-16
- SLS-PP-1404-20-20
- SLS-PP-1404-24-24
- SLS-PP-1404-32-32

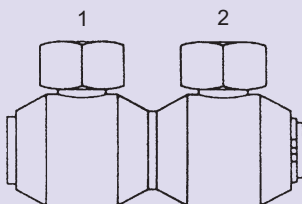

SLS-PP-1406

- (1) (2) Fem. Pipe Swivel

- SLS-PP-1406-04-04
- SLS-PP-1406-06-06
- SLS-PP-1406-08-08
- SLS-PP-1406-12-12
- SLS-PP-1406-16-16
- SLS-PP-1406-20-20
- SLS-PP-1406-24-24
- SLS-PP-1406-32-32

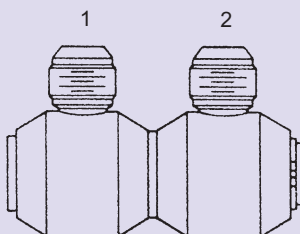

SLS-PP-2403

- (1) (2) Male JIC

- SLS-PP-2403-05-05
- SLS-PP-2403-06-06
- SLS-PP-2403-08-08
- SLS-PP-2403-10-08
- SLS-PP-2403-10-10
- SLS-PP-2403-12-12
- SLS-PP-2403-16-16
- SLS-PP-2403-20-20
- SLS-PP-2403-24-24
- SLS-PP-2403-32-32

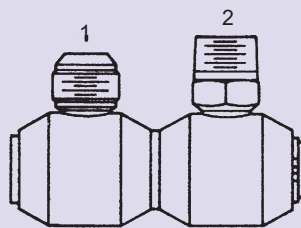

SLS-PP-2404

- (1) Male JIC
- (2) Male Pipe

- SLS-PP-2404-05-04
- SLS-PP-2404-06-04
- SLS-PP-2404-06-06
- SLS-PP-2404-08-04
- SLS-PP-2404-08-06
- SLS-PP-2404-08-08
- SLS-PP-2404-10-08
- SLS-PP-2404-12-12
- SLS-PP-2404-16-16
- SLS-PP-2404-20-20
- SLS-PP-2404-24-24
- SLS-PP-2404-32-32

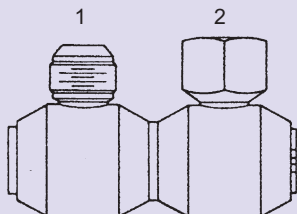

SLS-PP-2405

- (1) Male JIC
- (2) Fem. Pipe

- SLS-PP-2405-05-04
- SLS-PP-2405-05-06
- SLS-PP-2405-06-04
- SLS-PP-2405-06-06
- SLS-PP-2405-08-06
- SLS-PP-2405-08-08
- SLS-PP-2405-10-08
- SLS-PP-2405-12-12
- SLS-PP-2405-16-16
- SLS-PP-2405-20-20
- SLS-PP-2405-24-24
- SLS-PP-2405-32-32

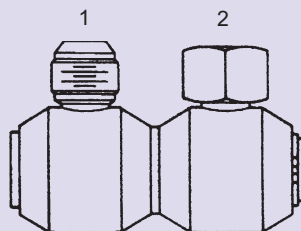

SLS-PP-2800

- (1) Male JIC
- (2) Fem. Pipe Swivel

- SLS-PP-2800-05-04
- SLS-PP-2800-05-06
- SLS-PP-2800-06-04
- SLS-PP-2800-06-06
- SLS-PP-2800-08-06
- SLS-PP-2800-08-08

- SLS-PP-2800-10-08
- SLS-PP-2800-12-12
- SLS-PP-2800-16-16
- SLS-PP-2800-20-20
- SLS-PP-2800-24-24
- SLS-PP-2800-32-32

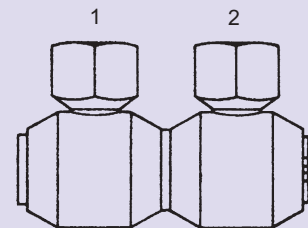

SLS-PP-5000

- (1) Fem. Pipe
- (2) Fem. Pipe

- SLS-PP-5000-04-04
- SLS-PP-5000-06-06
- SLS-PP-5000-08-08
- SLS-PP-5000-12-12
- SLS-PP-5000-16-16
- SLS-PP-5000-20-20
- SLS-PP-5000-24-24
- SLS-PP-5000-32-32

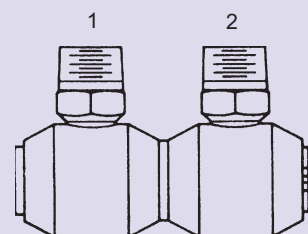

SLS-PP-5404

- (1) (2) Male Pipe

- SLS-PP-5404-04-04
- SLS-PP-5404-06-06
- SLS-PP-5404-08-08
- SLS-PP-5404-12-12
- SLS-PP-5404-16-16
- SLS-PP-5404-20-20
- SLS-PP-5404-24-24
- SLS-PP-5404-32-32

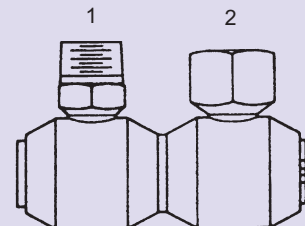

SLS-PP-5405

- (1) Male Pipe
- (2) Fem. Pipe

- SLS-PP-5405-04-04
- SLS-PP-5405-04-06
- SLS-PP-5405-06-06
- SLS-PP-5405-08-08
- SLS-PP-5405-12-12
- SLS-PP-5405-16-16
- SLS-PP-5405-20-20
- SLS-PP-5405-24-24
- SLS-PP-5405-32-32

STEEL LIVE SWIVELS -PARALLEL PLANE (180° 3000 PSI)

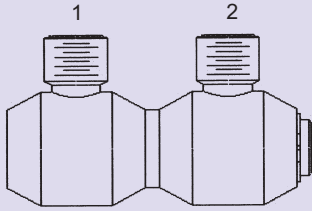

SLS-PP-OFS-2403

- (1) Male O-Ring Face Seal
- (2) Male O-Ring Face Seal

SLS-PP-OFS-2403-04-04
 SLS-PP-OFS-2403-06-04
 SLS-PP-OFS-2403-06-06
 SLS-PP-OFS-2403-08-04
 SLS-PP-OFS-2403-08-08
 SLS-PP-OFS-2403-10-08
 SLS-PP-OFS-2403-10-10
 SLS-PP-OFS-2403-12-12
 SLS-PP-OFS-2403-16-16
 SLS-PP-OFS-2403-20-20
 SLS-PP-OFS-2403-24-24

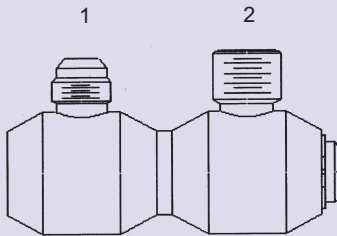

SLS-PP-OFS-6416

- (1) Male JIC
- (2) Male O-Ring Face Seal

SLS-PP-OFS-6416-06-06
 SLS-PP-OFS-6416-08-08
 SLS-PP-OFS-6416-10-10
 SLS-PP-OFS-6416-12-12
 SLS-PP-OFS-6416-16-16
 SLS-PP-OFS-6416-20-20
 SLS-PP-OFS-6416-24-24

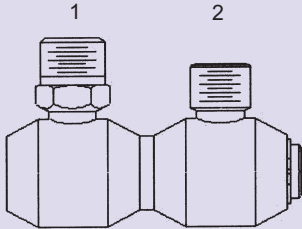

SLS-PP-OFS-6476

- (1) Male Pipe
- (2) Male O-Ring Face Seal

SLS-PP-OFS-6476-04-06
 SLS-PP-OFS-6476-06-08
 SLS-PP-OFS-6476-08-10
 SLS-PP-OFS-6476-12-12
 SLS-PP-OFS-6476-16-16
 SLS-PP-OFS-6476-20-20
 SLS-PP-OFS-6476-24-24

Styles may vary from picture

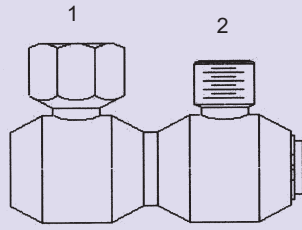

SLS-PP-OFS-6486

- (1) Fem. Pipe
- (2) Male O-Ring Face Seal

SLS-PP-OFS-6486-04-06
 SLS-PP-OFS-6486-06-08
 SLS-PP-OFS-6486-08-10
 SLS-PP-OFS-6486-12-12
 SLS-PP-OFS-6486-16-16
 SLS-PP-OFS-6486-20-20
 SLS-PP-OFS-6486-24-24

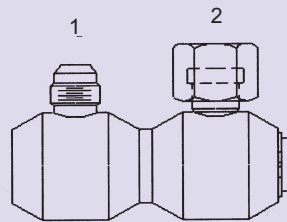

SLS-PP-OFS-6510

- (1) Male JIC
- (2) Fem. O-Ring Face Seal

SLS-PP-OFS-6510-05-06
 SLS-PP-OFS-6510-06-06
 SLS-PP-OFS-6510-08-06
 SLS-PP-OFS-6510-08-08
 SLS-PP-OFS-6510-08-10
 SLS-PP-OFS-6510-10-08
 SLS-PP-OFS-6510-10-10
 SLS-PP-OFS-6510-12-12
 SLS-PP-OFS-6510-16-16
 SLS-PP-OFS-6510-20-20
 SLS-PP-OFS-6510-24-24

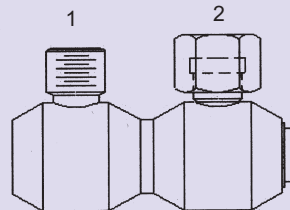

SLS-PP-OFS-6560

- (1) Male O-Ring Face Seal
- (2) Fem. O-Ring Face Seal Swivel

SLS-PP-OFS-6560-04-06
 SLS-PP-OFS-6560-06-06
 SLS-PP-OFS-6560-08-06
 SLS-PP-OFS-6560-08-08
 SLS-PP-OFS-6560-08-10
 SLS-PP-OFS-6560-10-08
 SLS-PP-OFS-6560-10-10
 SLS-PP-OFS-6560-12-12
 SLS-PP-OFS-6560-16-16
 SLS-PP-OFS-6560-20-20
 SLS-PP-OFS-6560-24-24

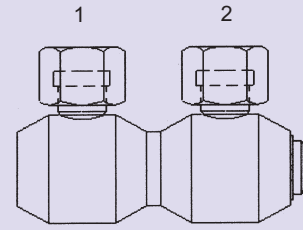

SLS-PP-OFS-6565

- (1) Fem. O-Ring Face Seal Swivel
- (2) Fem. O-Ring Face Seal Swivel

SLS-PP-OFS-6565-06-06
 SLS-PP-OFS-6565-08-08
 SLS-PP-OFS-6565-10-08
 SLS-PP-OFS-6565-10-10
 SLS-PP-OFS-6565-12-12
 SLS-PP-OFS-6565-16-16
 SLS-PP-OFS-6565-20-20
 SLS-PP-OFS-6565-24-24

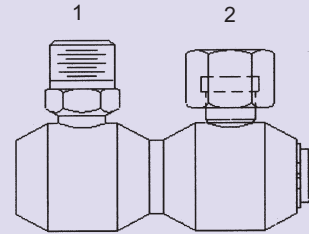

SLS-PP-OFS-6570

- (1) Fem. O-Ring Face Seal Swivel
- (2) Male Pipe

SLS-PP-OFS-6570-04-06
 SLS-PP-OFS-6570-06-06
 SLS-PP-OFS-6570-08-08
 SLS-PP-OFS-6570-08-10
 SLS-PP-OFS-6570-12-12
 SLS-PP-OFS-6570-16-16
 SLS-PP-OFS-6570-20-20
 SLS-PP-OFS-6570-24-24

STAINLESS STEEL LIVE SWIVELS -PARALLEL PLANE- O-RING FACE SEAL

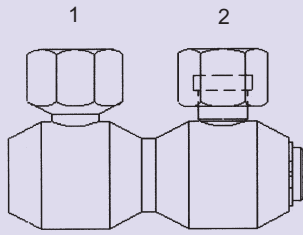

SLS-PP-OFS-6580

- (1) Fem. Pipe
- (2) Fem. O-Ring Face Seal Swivel

SLS-PP-OFS-6580-04-06
SLS-PP-OFS-6580-06-06
SLS-PP-OFS-6580-08-08
SLS-PP-OFS-6580-08-10
SLS-PP-OFS-6580-12-12
SLS-PP-OFS-6580-16-16
SLS-PP-OFS-6580-20-20
SLS-PP-OFS-6580-24-24

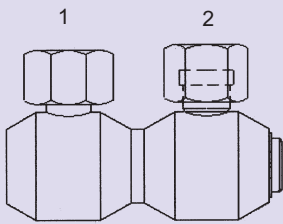

SLS-PP-OFS-6590

- (1) Fem. Pipe Swivel
- (2) Fem. O-Ring Face Seal Swivel

SLS-PP-OFS-6590-04-06
SLS-PP-OFS-6590-08-08
SLS-PP-OFS-6590-08-10
SLS-PP-OFS-6590-12-12
SLS-PP-OFS-6590-16-16
SLS-PP-OFS-6590-20-20
SLS-PP-OFS-6590-24-24

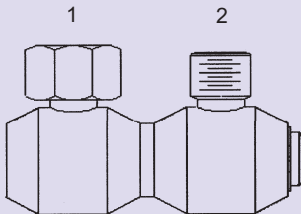

SLS-PP-OFS-6596

- (1) Fem. Pipe Swivel
- (2) Male O-Ring Face Seal

SLS-PP-OFS-6596-04-06
SLS-PP-OFS-6596-06-08
SLS-PP-OFS-6596-08-10
SLS-PP-OFS-6596-12-12
SLS-PP-OFS-6596-16-16
SLS-PP-OFS-6596-20-20
SLS-PP-OFS-6596-24-24

Styles may vary from picture

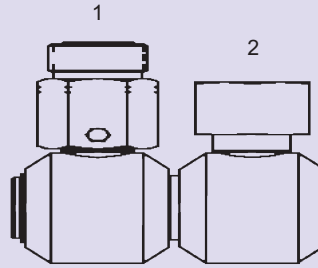

SLS-OFS-DP-PP-6500

- (1) Male O-Ring Face Seal
- (2) Fem. O-Ring Face Seal

SLS-OFS-DP-PP-6500-12-12

STAINLESS STEEL LIVE SWIVELS

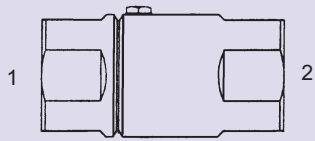

SS-LS-5000

- (1) Fem. Pipe - Stem
- (2) Fem. Pipe - Barrel

SS-LS-5000-04-04
 SS-LS-5000-06-06
 SS-LS-5000-08-08
 SS-LS-5000-12-12
 SS-LS-5000-16-16
 SS-LS-5000-20-20
 SS-LS-5000-24-24
 SS-LS-5000-32-32

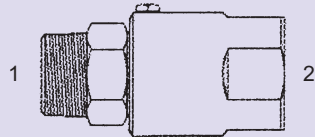

SS-LS-5405

- (1) Male Pipe - Stem
- (2) Fem. Pipe - Barrel

SS-LS-5405-04-04
 SS-LS-5405-06-06
 SS-LS-5405-08-08
 SS-LS-5405-12-12
 SS-LS-5405-16-16

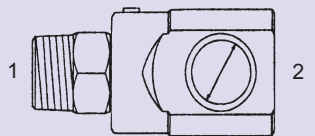

SS-LS-5502-SB - 90°

- (1) Male Pipe - Stem
- (2) Fem. Pipe - Barrel
(Short Body)

SS-LS-5502-SB-04-04
 SS-LS-5502-SB-06-06
 SS-LS-5502-SB-08-08
 SS-LS-5502-SB-12-12
 SS-LS-5502-SB-16-16

Styles may vary from picture

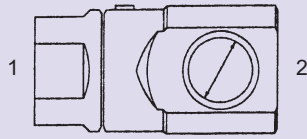

SS-LS-5504-SB - 90°

- (1) Male Pipe - Stem
- (2) Fem. Pipe - Barrel
(Short Body)

SS-LS-5504-SB-04-04
 SS-LS-5504-SB-06-06
 SS-LS-5504-SB-08-08
 SS-LS-5504-SB-12-12
 SS-LS-5504-SB-16-16
 SS-LS-5504-SB-20-20
 SS-LS-5504-SB-24-24
 SS-LS-5504-SB-32-32

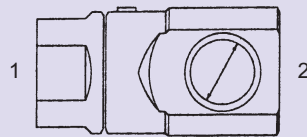

SS-LS-5504-SB-HP - 90°

High Pressure

- (1) Male Pipe - Stem
- (2) Fem. Pipe - Barrel
(Short Body)

SS-LS-5504-SB-HP-12-12

PARTS INDEX

SLS-1501	1	SLS-6841-4K-O	8	SLS-OFS-6580	17
SLS-1501-4K	1	SLS-6841-5K-O	9	SLS-OFS-6816	17
SLS-1501-5K	1	SLS-6841-LH-O	9	SLS-OFS-6816-4K	17
SLS-1502	1	SLS-6843-O	9	SLS-OFS-6816-5K	17
SLS-1502-4K	1	SLS-6843-4K-O	9	SLS-OFS-6840-O	18
SLS-1502-5K	1	SLS-6845-O	9	SLS-OFS-6840-5K-O	18
SLS-1704-61	1	SLS-6845-SB-O	9	SLS-OFS-6846-O	18
SLS-1704-62	1	SLS-6849-O	9	SLS-OFS-6846-4K-O	18
SLS-2403	1	SLS-6901-O	9	SLS-OFS-6846-5K-O	18
SLS-2405	2	SLS-6975-SB	9	SLS-OFS-6846-LH-O	18
SLS-2412	2	SLS-6985-SB	9	SLS-OFS-6861	18
SLS-2421	2	SLS-DP-2500	10	SLS-OFS-6861-5K	19
SLS-2471	2	SLS-DP-2500-4K	10	SLS-OFS-6866	19
SLS-2472	2	SLS-DP-2500-5K	10	SLS-OFS-6866-4K	19
SLS-2481	2	SLS-DP-2502	10	SLS-OFS-6866-5K	19
SLS-2500	2	SLS-DP-2571	10	SLS-OFS-6876	19
SLS-2500-4K	2	SLS-DP-2571-4K	10	SLS-OFS-6876-4K	19
SLS-2500-5K	2	SLS-DP-2571-5K	10	SLS-OFS-6876-5K	19
SLS-2500-LH	3	SLS-DP-2581	11	SLS-OFS-6876-5K-LH	20
SLS-2501	3	SLS-DP-5502	11	SLS-OFS-6876-LH	20
SLS-2502	3	SLS-DP-5502-4K	11	SLS-OFS-6886	20
SLS-2502-SB	3	SLS-DP-5502-5K	11	SLS-OFS-6886-4K	20
SLS-2519	3	SLS-DP-5504	11	SLS-OFS-6886-5K	20
SLS-2571	3	SLS-DP-5504-4K	11	SLS-OFS-DP-PP-6500	23
SLS-2571-4K	4	SLS-DP-5504-5K	11	SLS-PP-1404	21
SLS-2571-5K	4	SLS-DP-6805-O	11	SLS-PP-1406	21
SLS-2573	4	SLS-DP-6841-O	12	SLS-PP-2403	21
SLS-2573-4K	4	SLS-DP-6841-4K-O	12	SLS-PP-2404	21
SLS-2573-5K	4	SLS-DP-6841-5K-O	12	SLS-PP-2405	21
SLS-2581	4	SLS-DP-OFS-6816	12	SLS-PP-2800	21
SLS-2581-4K	4	SLS-DP-OFS-6846-O	12	SLS-PP-5000	21
SLS-2583	4	SLS-DP-OFS-6846-4K	12	SLS-PP-5404	21
SLS-2583-4K	5	SLS-DP-OFS-6846-5K	12	SLS-PP-5405	21
SLS-2710	5	SLS-DP-OFS-6861	12	SLS-PP-OFS-2403	22
SLS-2711	5	SLS-DP-OFS-6866	13	SLS-PP-OFS-6416	22
SLS-2712	5	SLS-DP-OFS-6866-4K	13	SLS-PP-OFS-6476	22
SLS-2715-SB	5	SLS-DP-OFS-6866-5K	13	SLS-PP-OFS-6486	22
SLS-2717	5	SLS-DP-OFS-6868	13	SLS-PP-OFS-6510	22
SLS-2718-SB	5	SLS-DP-OFS-6876	13	SLS-PP-OFS-6560	22
SLS-2719	5	SLS-DP-OFS-6886	13	SLS-PP-OFS-6565	22
SLS-5000	5	SLS-OFS-2406	14	SLS-PP-OFS-6570	22
SLS-5000-HP	6	SLS-OFS-2507	14	SLS-PP-OFS-6580	23
SLS-5405	6	SLS-OFS-2509	14	SLS-PP-OFS-6590	23
SLS-5405-HP	6	SLS-OFS-2510	14	SLS-PP-OFS-6596	23
SLS-5500	6	SLS-OFS-2510-5K	14	SS-LS-5000	24
SLS-5502	6	SLS-OFS-2567	14	SS-LS-5405	24
SLS-5502-SB	6	SLS-OFS-2700-LN	15	SS-LS-5502-SB	24
SLS-5502-SB-HP	6	SLS-OFS-2701-LN-4K	15	SS-LS-5504-SB	24
SLS-5504	6	SLS-OFS-2701-LN-5K	15	SS-LS-5504-SB-HP	24
SLS-5504-SB	6	SLS-OFS-2716-LN-4K	15		
SLS-5504-SB-HP	7	SLS-OFS-2716-LN-5K	15		
SLS-5587	7	SLS-OFS-6426	15		
SLS-6402-O	7	SLS-OFS-6446-O	15		
SLS-6441-O	7	SLS-OFS-6461	15		
SLS-6448-O	7	SLS-OFS-6466	16		
SLS-6455	7	SLS-OFS-6468	16		
SLS-6513	7	SLS-OFS-6476	16		
SLS-6513-4K	7	SLS-OFS-6500	16		
SLS-6573	7	SLS-OFS-6500-5K	16		
SLS-6573-4K	8	SLS-OFS-6510	16		
SLS-6805-O	8	SLS-OFS-6510-5K	16		
SLS-6805-SB-O	8	SLS-OFS-6560	16		
SLS-6806-O	8	SLS-OFS-6560-4K	17		
SLS-6814-4K-O	8	SLS-OFS-6560-5K	17		
SLS-6814-5K-O	8	SLS-OFS-6565	17		
SLS-6815-SB	8	SLS-OFS-6565-5K	17		
SLS-6841-O	8	SLS-OFS-6570	17		



Adapter & Fitting Specialist

1-800-348-8467