

# **FUI** **FITTINGS** **UNLIMITED** INC

*Adapter & Fitting Specialist*

www.myfui.com

---

## Standard Parts List

---

### CORPORATE SALES

#### **DALLAS, TX**

3000 AVENUE F

ARLINGTON, TX 76011

(800) 348-8467 (281) 500-9570 FAX

#### **CLEVELAND, OH**

(800) 348-8467 (817) 860-8517 FAX

#### **HOUSTON, TX**

(800) 633-5340 (281) 500-9570 FAX

#### **SALT LAKE CITY, UT**

(800) 348-8467 (817) 860-8517 FAX

#### **CANADA -AURORA, ONTARIO**

(877) 644-4403 (905) 713-3927 FAX

#### **ATLANTA, GA**

(800) 348-8467 (817) 860-8517 FAX

#### **TERMS -**

All invoices are 2%-10 Net 30 with approved credit. A 1½% finance charge will be assessed on all past due accounts. All accounts due and payable in Arlington, Tarrant County, Texas.

#### **MINIMUM ORDER -**

\$25.00 per order

#### **POR -**

Price On Request

#### **RETURNS -**

Fittings may be returned only with authorization from FITTINGS UNLIMITED, INC. - subject to our inspection and must be shipped freight prepaid within 30 days of original shipment. A restocking fee of 20% or \$10.00, whichever is greater, will apply. In case of shipping errors, notification must be made within 30 days to receive an adjustment. Special fittings and made to order items are non-cancelable and not returnable without written consent of FITTINGS UNLIMITED, INC.



*Steel Live Swivels*

*“It is the policy of Fittings Unlimited, Inc.  
to maintain and improve our customer satisfaction by  
providing hydraulic and pneumatic fittings and  
accessories that consistently meet our customer’s  
specified product and delivery requirements.”*

# STEEL LIVE SWIVELS

Styles may vary from picture

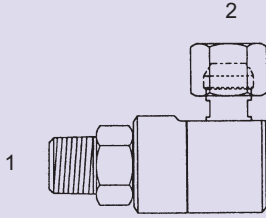

**SLS-1501 - 90°**

- (1) Male Pipe - Stem
- (2) Fem. Pipe Swivel - Barrel

SLS-1501-04-04	148.70
SLS-1501-04-06	148.70
SLS-1501-06-04	148.70
SLS-1501-06-06	148.70
SLS-1501-08-08	157.55
SLS-1501-12-12	243.15
SLS-1501-16-16	307.30
SLS-1501-20-20	508.70
SLS-1501-24-24	1183.60
SLS-1501-32-32	1839.10

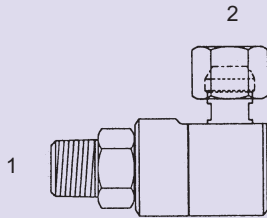

**SLS-1501-4K - 90°**

4000 PSI

- (1) Male Pipe - Stem
- (2) Fem. Pipe Swivel - Barrel

SLS-1501-4K-08-08	295.95
-------------------	--------

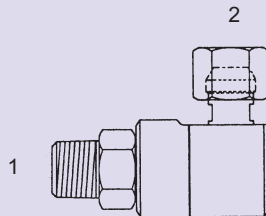

**SLS-1501-5K - 90°**

5000 PSI

- (1) Male Pipe - Stem
- (2) Fem. Pipe Swivel - Barrel

SLS-1501-5K-04-04	286.10
SLS-1501-5K-06-06	304.50

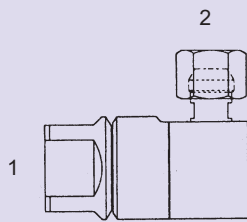

**SLS-1502 - 90°**

- (1) Fem. Pipe - Stem
- (2) Fem. Pipe Swivel - Barrel

SLS-1502-04-04	148.70
SLS-1502-04-06	148.70
SLS-1502-06-04	148.70
SLS-1502-06-06	148.70
SLS-1502-08-08	157.55
SLS-1502-12-12	243.15
SLS-1502-16-16	307.30
SLS-1502-20-20	508.70
SLS-1502-24-24	1183.60
SLS-1502-32-32	1839.10

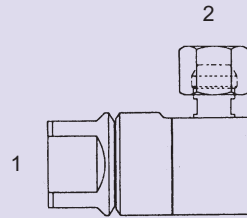

**SLS-1502-4K - 90°**

4000 PSI

- (1) Fem. Pipe - Stem
- (2) Fem. Pipe Swivel - Barrel

SLS-1502-4K-08-08	304.30
-------------------	--------

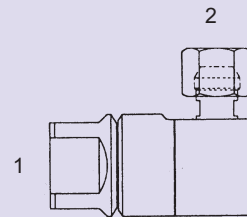

**SLS-1502-5K - 90°**

5000 PSI

- (1) Fem. Pipe - Stem
- (2) Fem. Pipe Swivel - Barrel

SLS-1502-5K-06-06	287.85
-------------------	--------

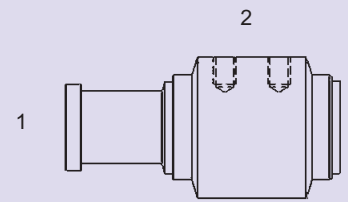

**SLS-1704-61 - 90°**

- (1) O-Ring Flange Head - Stem
- (2) Flange Block - Tapped Holes - Barrel  
Code 61

SLS-1704-61-12-12	1001.85
SLS-1704-61-16-16	1280.90
SLS-1704-61-20-20	1401.25
SLS-1704-61-24-24	1930.55
SLS-1704-61-32-32	2912.00
SLS-1704-61-40-40	3850.45

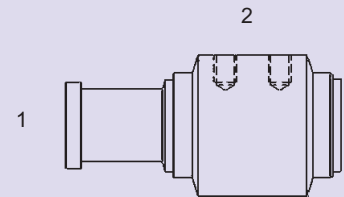

**SLS-1704-62 - 90°**

- (1) O-Ring Flange Head - Stem
- (2) Flange Block - Tapped Holes - Barrel  
Code 62

SLS-1704-62-08-08	978.15
SLS-1704-62-12-12	1284.75
SLS-1704-62-16-16	1427.00
SLS-1704-62-20-20	1891.25
SLS-1704-62-24-24	2942.25
SLS-1704-62-32-32	3916.95

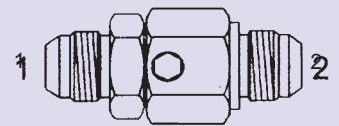

**SLS-2403 - Str.**

- (1) Male JIC - Stem
- (2) Male JIC - Barrel

SLS-2403-06-06	123.60
SLS-2403-08-08	123.60
SLS-2403-10-10	143.95
SLS-2403-12-12	143.95
SLS-2403-16-16	258.15
SLS-2403-20-20	467.60
SLS-2403-24-24	1079.20
SLS-2403-32-32	1725.70

# STEEL LIVE SWIVELS

Styles may vary from picture

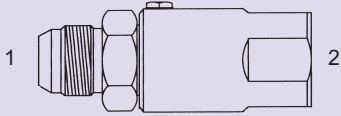

**SLS-2405 - Str.**

- (1) Male JIC- Stem
- (2) Fem. Pipe - Barrel

SLS-2405-04-04	146.40
SLS-2405-06-04	146.40
SLS-2405-08-06	151.55
SLS-2405-08-08	160.40
SLS-2405-10-08	160.40
SLS-2405-12-12	200.85
SLS-2405-16-16	273.45
SLS-2405-20-20	467.60
SLS-2405-24-24	1102.00

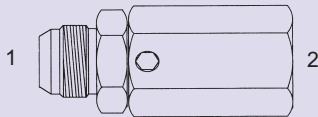

**SLS-2412 - Str.**

- (1) Male JIC- Stem
- (2) Fem. JIC - Barrel

SLS-2412-04-04	146.40
SLS-2412-06-06	146.40
SLS-2412-08-08	160.40
SLS-2412-10-10	160.40
SLS-2412-12-12	200.85
SLS-2412-16-16	273.45
SLS-2412-20-20	467.60

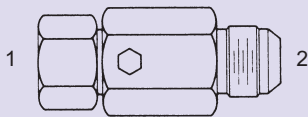

**SLS-2421 - Str.**

- (1) Fem. JIC- Stem
- (2) Male JIC - Barrel

SLS-2421-06-06	123.60
SLS-2421-08-06	123.60
SLS-2421-08-08	123.60
SLS-2421-10-10	144.00
SLS-2421-12-12	144.00
SLS-2421-14-14	214.60
SLS-2421-16-16	258.15
SLS-2421-20-20	481.45
SLS-2421-24-24	1079.25
SLS-2421-32-32	1725.70

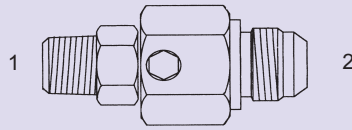

**SLS-2471 - Str.**

- (1) Male Pipe - Stem
- (2) Male JIC - Barrel

SLS-2471-04-04	254.50
SLS-2471-04-06	123.60
SLS-2471-04-08	123.60
SLS-2471-06-06	123.60
SLS-2471-06-08	123.60
SLS-2471-08-08	143.95
SLS-2471-08-10	144.00
SLS-2471-08-12	143.95
SLS-2471-12-10	143.95
SLS-2471-12-12	144.00
SLS-2471-16-16	258.15
SLS-2471-20-20	467.60
SLS-2471-24-24	1079.25
SLS-2471-32-32	1725.70

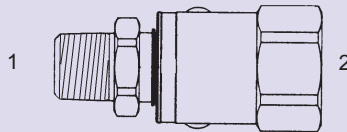

**SLS-2472 - Str.**

- (1) Male Pipe - Stem
- (2) Fem. JIC - Barrel

SLS-2472-06-06	273.85
SLS-2472-08-08	301.90

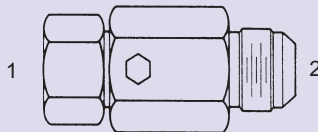

**SLS-2481 - Str.**

- (1) Fem. Pipe - Stem
- (2) Male JIC - Barrel

SLS-2481-04-04	280.05
SLS-2481-04-06	123.60
SLS-2481-06-06	123.60
SLS-2481-06-08	123.60
SLS-2481-08-08	143.95
SLS-2481-08-10	144.00
SLS-2481-08-12	143.95
SLS-2481-12-10	143.95
SLS-2481-12-12	144.00
SLS-2481-16-16	258.15
SLS-2481-20-20	481.45
SLS-2481-24-24	1079.25
SLS-2481-32-32	1725.70

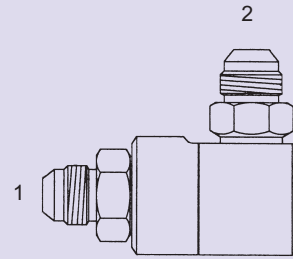

**SLS-2500 - 90°**

- (1) Male JIC - Stem
- (2) Male JIC - Barrel

SLS-2500-04-04	151.80
SLS-2500-05-05	148.70
SLS-2500-05-06	148.70
SLS-2500-06-05	148.70
SLS-2500-06-06	148.70
SLS-2500-06-08	148.70
SLS-2500-08-06	148.70
SLS-2500-08-08	148.70
SLS-2500-08-10	157.50
SLS-2500-10-08	157.50
SLS-2500-10-10	157.55
SLS-2500-12-12	243.15
SLS-2500-16-16	307.30
SLS-2500-20-20	508.70
SLS-2500-24-24	1183.60
SLS-2500-32-32	1839.10

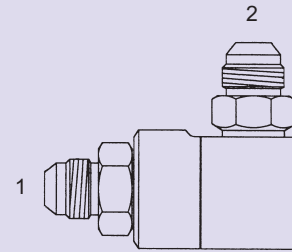

**SLS-2500-4K - 90°**

- 4000 PSI
- (1) Male JIC - Stem
- (2) Male JIC - Barrel

SLS-2500-4K-12-12	404.25
-------------------	--------

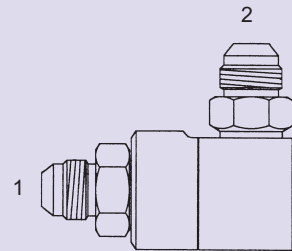

**SLS-2500-5K - 90°**

- 5000 PSI
- (1) Male JIC - Stem
- (2) Male JIC - Barrel

SLS-2500-5K-05-05	260.10
SLS-2500-5K-05-06	260.10
SLS-2500-5K-06-05	260.10
SLS-2500-5K-06-06	260.10
SLS-2500-5K-06-08	260.10
SLS-2500-5K-08-06	260.10
SLS-2500-5K-08-08	260.10
SLS-2500-5K-08-10	276.65
SLS-2500-5K-10-08	276.65
SLS-2500-5K-10-10	276.65

# STEEL LIVE SWIVELS

Styles may vary from picture

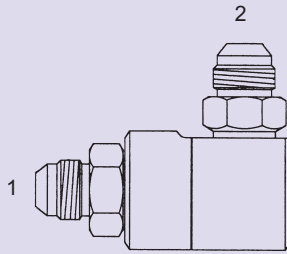

**SLS-2500-LH - 90°**

Large Hex  
(1) Male JIC - Stem  
(2) Male JIC - Barrel

SLS-2500-LH-08-08	157.50
-------------------	--------

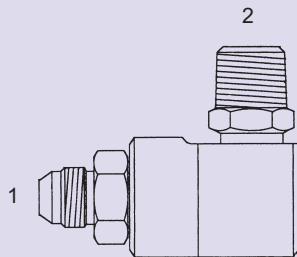

**SLS-2501 - 90°**

(1) Male JIC - Stem  
(2) Male Pipe - Barrel

SLS-2501-04-04	151.80
SLS-2501-05-04	148.70
SLS-2501-05-06	148.70
SLS-2501-06-04	148.70
SLS-2501-06-06	148.70
SLS-2501-08-06	148.70
SLS-2501-08-08	157.50
SLS-2501-10-06	189.15
SLS-2501-10-08	157.55
SLS-2501-12-12	243.15
SLS-2501-16-16	307.30
SLS-2501-20-20	508.70
SLS-2501-24-24	1183.60
SLS-2501-32-32	1839.10

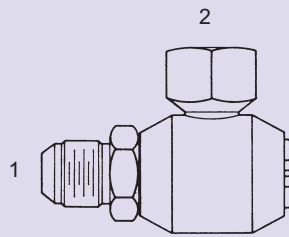

**SLS-2502 - 90°**

(1) Male JIC - Stem  
(2) Fem. Pipe - Barrel

SLS-2502-04-04	151.80
SLS-2502-05-06	148.70
SLS-2502-06-04	148.70
SLS-2502-06-06	148.70
SLS-2502-08-06	148.70
SLS-2502-08-08	157.55
SLS-2502-10-08	157.55
SLS-2502-12-12	243.15
SLS-2502-16-16	307.30
SLS-2502-20-20	580.85
SLS-2502-24-24	1183.60
SLS-2502-32-32	1839.10

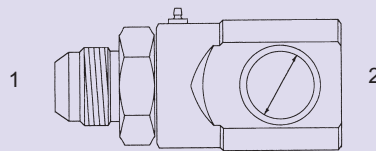

**SLS-2502-SB - 90°**

(1) Male JIC - Stem  
(2) Fem. Pipe - Barrel  
(Short Body)

SLS-2502-SB-08-06	169.00
SLS-2502-SB-10-06	169.00
SLS-2502-SB-10-08	169.00
SLS-2502-SB-12-12	404.75
SLS-2502-SB-16-16	287.70
SLS-2502-SB-20-20	472.00
SLS-2502-SB-24-24	1102.00

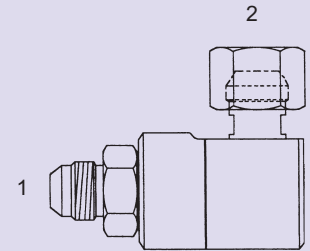

**SLS-2519 - 90°**

(1) Male JIC - Stem  
(2) Fem. Pipe Swivel - Barrel

SLS-2519-05-04	148.70
SLS-2519-05-06	148.70
SLS-2519-06-04	148.70
SLS-2519-06-06	148.70
SLS-2519-08-04	148.70
SLS-2519-08-06	148.70
SLS-2519-08-08	157.50
SLS-2519-10-08	157.55
SLS-2519-12-12	243.15
SLS-2519-16-16	307.30
SLS-2519-20-20	508.70
SLS-2519-24-24	1183.60
SLS-2519-32-32	1839.10

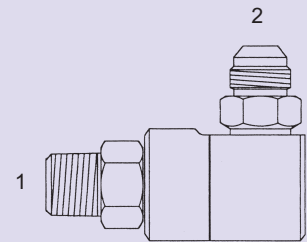

**SLS-2571 - 90°**

(1) Male Pipe - Stem  
(2) Male JIC - Barrel

SLS-2571-04-04	151.80
SLS-2571-04-05	148.70
SLS-2571-04-06	148.70
SLS-2571-04-08	148.70
SLS-2571-06-05	148.70
SLS-2571-06-06	148.70
SLS-2571-06-08	148.70
SLS-2571-08-08	157.55
SLS-2571-08-10	157.55
SLS-2571-12-12	243.15
SLS-2571-16-16	307.30
SLS-2571-20-20	508.70
SLS-2571-24-24	1183.60
SLS-2571-32-32	1839.10

# STEEL LIVE SWIVELS

Styles may vary from picture

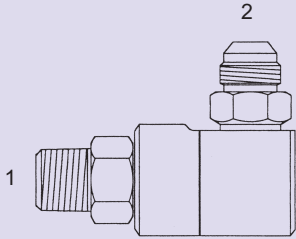

**SLS-2571-4K - 90°**

4000 PSI

- (1) Male Pipe - Stem
- (2) Male JIC - Barrel

SLS-2571-4K-12-12 338.50

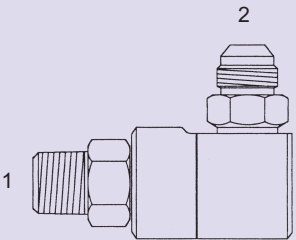

**SLS-2571-5K - 90°**

5000 PSI

- (1) Male Pipe - Stem
- (2) Male JIC - Barrel

SLS-2571-5K-04-04 253.65  
 SLS-2571-5K-06-06 262.90  
 SLS-2571-5K-08-08 327.35

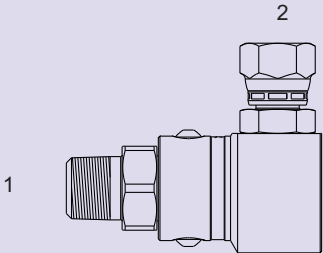

**SLS-2573 - 90°**

- (1) Male Pipe - Stem
- (2) Female JIC - Barrel

SLS-2573-16-16 487.85

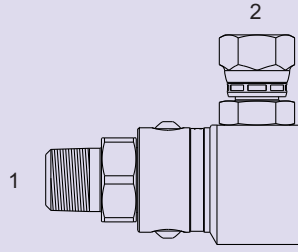

**SLS-2573-4K - 90°**

4000 PSI

- (1) Male Pipe - Stem
- (2) Female JIC - Barrel

SLS-2573-4K-12-12 464.45

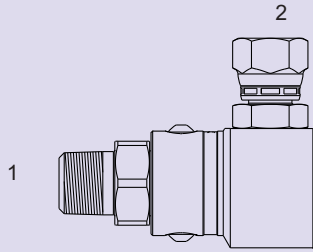

**SLS-2573-5K - 90°**

5000 PSI

- (1) Male Pipe - Stem
- (2) Female JIC - Barrel

SLS-2573-5K-08-08 325.00

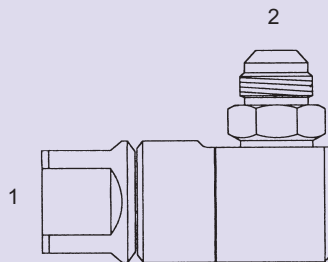

**SLS-2581 - 90°**

- (1) Fem. Pipe - Stem
- (2) Male JIC - Barrel

SLS-2581-04-04 151.85  
 SLS-2581-04-05 148.70  
 SLS-2581-04-06 148.70  
 SLS-2581-06-05 148.70  
 SLS-2581-06-06 148.70  
 SLS-2581-06-08 148.70  
 SLS-2581-08-08 157.55  
 SLS-2581-08-10 157.55  
 SLS-2581-12-12 243.15  
 SLS-2581-16-16 307.30  
 SLS-2581-20-20 508.70  
 SLS-2581-24-24 1183.60  
 SLS-2581-32-32 1839.10

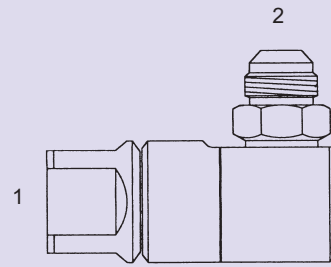

**SLS-2581-4K - 90°**

4000 PSI

- (1) Fem. Pipe - Stem
- (2) Male JIC - Barrel

SLS-2581-4K-12-12 404.55

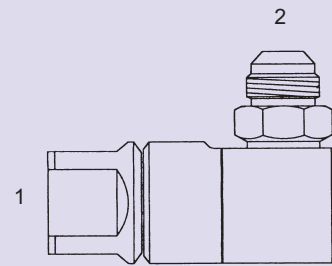

**SLS-2581-5K - 90°**

5000 PSI

- (1) Fem. Pipe - Stem
- (2) Male JIC - Barrel

SLS-2581-5K-06-06 290.55  
 SLS-2581-5K-08-08 322.15

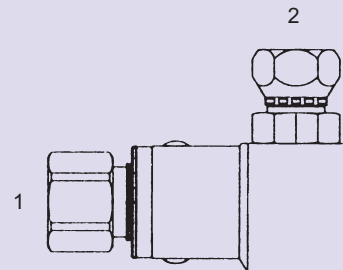

**SLS-2583 - 90°**

- (1) Fem. Pipe - Stem
- (2) Fem. JIC Swivel - Barrel

SLS-2583-04-04 162.15  
 SLS-2583-06-04 162.15  
 SLS-2583-06-06 169.00  
 SLS-2583-08-08 169.00

# STEEL LIVE SWIVELS

Styles may vary from picture

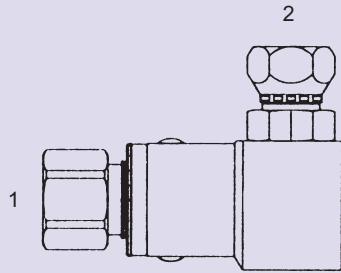

## SLS-2583-4K - 90°

4000 PSI

- (1) Fem. Pipe - Stem
- (2) Fem. JIC Swivel - Barrel

SLS-2583-4K-08-10	169.00
SLS-2583-4K-12-12	231.60
SLS-2583-4K-16-16	287.70
SLS-2583-4K-20-20	471.90
SLS-2583-4K-24-24	1102.00

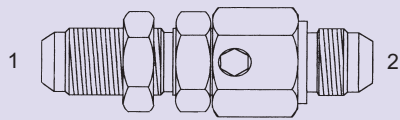

## SLS-2710 - Str.

- (1) Male JIC Bulkhead - Stem
- (2) Male JIC - Barrel

SLS-2710-08-08	180.75
SLS-2710-10-10	180.75
SLS-2710-12-12	226.25
SLS-2710-16-16	294.75

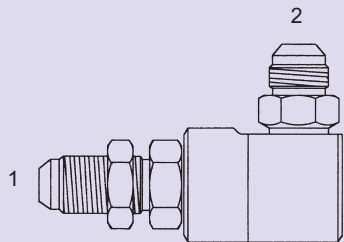

## SLS-2711 - 90°

- (1) Male JIC Bulkhead - Stem
- (2) Male JIC - Barrel

SLS-2711-08-08	214.90
SLS-2711-12-12	276.30
SLS-2711-16-16	354.90
SLS-2711-20-20	566.75

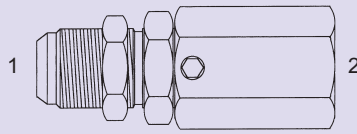

## SLS-2712 - Str.

- (1) Male JIC Bulkhead - Stem
- (2) Fem. JIC - Barrel

SLS-2712-08-08	180.75
SLS-2712-10-10	180.75
SLS-2712-12-12	226.25
SLS-2712-16-16	294.75
SLS-2712-20-20	487.90

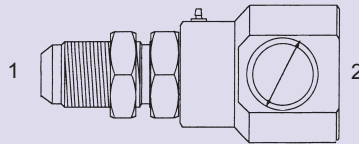

## SLS-2715-SB - 90°

- (1) Male JIC Bulkhead - Stem
- (2) Fem. O-Ring - Barrel  
(Short Body)

SLS-2715-SB-08-08	182.60
SLS-2715-SB-10-08	182.60
SLS-2715-SB-12-12	244.45
SLS-2715-SB-16-16	310.15
SLS-2715-SB-20-20	493.10

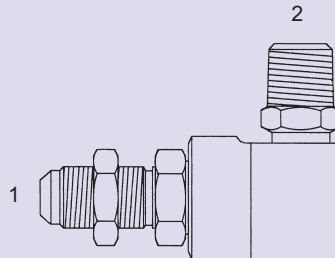

## SLS-2717 - 90°

- (1) Male JIC Bulkhead - Stem
- (2) Male Pipe - Barrel

SLS-2717-08-06	214.90
SLS-2717-08-08	214.90
SLS-2717-10-08	214.90
SLS-2717-12-12	276.30
SLS-2717-16-16	354.90
SLS-2717-20-20	566.75

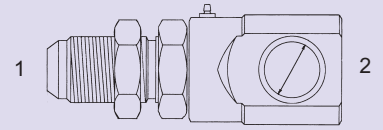

## SLS-2718-SB - 90°

- (1) Male JIC Bulkhead - Stem
- (2) Fem. Pipe - Barrel  
(Short Body)

SLS-2718-SB-08-06	189.15
SLS-2718-SB-08-08	182.60
SLS-2718-SB-10-06	182.60
SLS-2718-SB-10-08	182.60
SLS-2718-SB-12-12	244.45
SLS-2718-SB-16-16	310.15
SLS-2718-SB-20-20	493.10

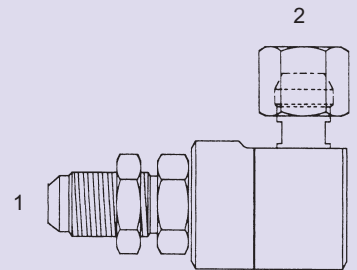

## SLS-2719 - 90°

- (1) Male JIC Bulkhead - Stem
- (2) Fem. Pipe Swivel - Barrel

SLS-2719-08-06	214.90
SLS-2719-08-08	214.90
SLS-2719-10-08	214.90
SLS-2719-12-12	276.30
SLS-2719-16-16	354.90
SLS-2719-20-20	566.75

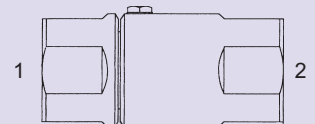

## SLS-5000 - Str.

- (1) Fem. Pipe - Stem
- (2) Fem. Pipe - Barrel

SLS-5000-02-02	173.00
SLS-5000-04-04	123.60
SLS-5000-04-06	123.60
SLS-5000-06-06	123.60
SLS-5000-08-08	144.00
SLS-5000-12-08	143.95
SLS-5000-12-12	144.00
SLS-5000-16-16	258.15
SLS-5000-20-20	467.60
SLS-5000-24-24	1079.25
SLS-5000-32-32	1725.70
SLS-5000-40-40	2269.85

# STEEL LIVE SWIVELS

Styles may vary from picture

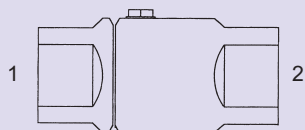

**SLS-5000-HP - Str.**  
High Pressure - 10,000 PSI  
(1) Fem. Pipe - Stem  
(2) Fem. Pipe - Barrel

SLS-5000-HP-08-08                      556.75

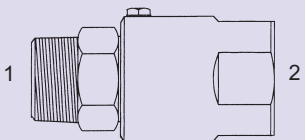

**SLS-5405 - Str.**  
(1) Male Pipe - Stem  
(2) Fem. Pipe - Barrel

SLS-5405-02-02	173.00
SLS-5405-04-04	123.60
SLS-5405-04-06	123.60
SLS-5405-06-04	123.60
SLS-5405-06-06	123.60
SLS-5405-08-08	144.00
SLS-5405-08-12	143.95
SLS-5405-12-08	143.95
SLS-5405-12-12	144.00
SLS-5405-16-16	258.15
SLS-5405-20-20	467.60
SLS-5405-24-24	1079.25
SLS-5405-32-32	1725.70

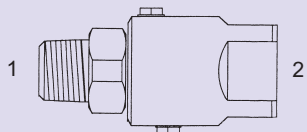

**SLS-5405-HP - Str.**  
High Pressure - 10,000 PSI  
(1) Male Pipe - Stem  
(2) Fem. Pipe - Barrel

SLS-5405-HP-08-08                      556.75

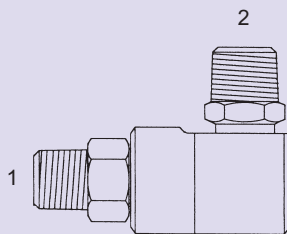

**SLS-5500 - 90°**  
(1) Male Pipe - Stem  
(2) Male Pipe - Barrel

SLS-5500-04-04	148.70
SLS-5500-04-06	148.70
SLS-5500-06-04	148.70
SLS-5500-06-06	148.70
SLS-5500-06-08	189.15
SLS-5500-08-06	189.15
SLS-5500-08-08	157.55
SLS-5500-12-12	243.15
SLS-5500-16-16	307.30
SLS-5500-20-20	508.70
SLS-5500-24-24	1183.60
SLS-5500-32-32	1839.10

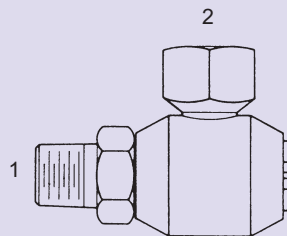

**SLS-5502 - 90°**  
(1) Male Pipe - Stem  
(2) Fem. Pipe - Barrel

SLS-5502-04-04	148.70
SLS-5502-04-06	148.70
SLS-5502-06-04	148.70
SLS-5502-06-06	148.70
SLS-5502-08-08	157.55
SLS-5502-12-12	243.15
SLS-5502-16-16	307.30
SLS-5502-20-20	580.85
SLS-5502-24-24	1183.60
SLS-5502-32-32	1839.10

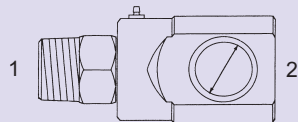

**SLS-5502-SB - 90°**  
(1) Male Pipe - Stem  
(2) Fem. Pipe - Barrel  
(Short Body)

SLS-5502-SB-02-02	190.70
SLS-5502-SB-04-04	162.15
SLS-5502-SB-06-06	169.00
SLS-5502-SB-08-08	169.00
SLS-5502-SB-12-12	231.55
SLS-5502-SB-16-16	287.70
SLS-5502-SB-20-20	472.00
SLS-5502-SB-24-24	1101.90
SLS-5502-SB-32-32	2163.40

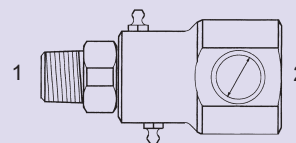

**SLS-5502-SB-HP - 90°**  
High Pressure - 10,000 PSI  
(1) Male Pipe - Stem  
(2) Fem. Pipe - Barrel  
(Short Body)

SLS-5502-SB-HP-08-08                      582.90

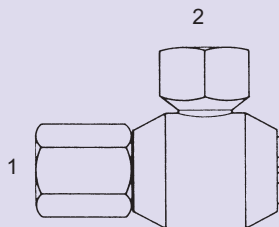

**SLS-5504 - 90°**  
(1) Fem. Pipe - Stem  
(2) Fem. Pipe - Barrel

SLS-5504-04-04	148.70
SLS-5504-04-06	148.70
SLS-5504-06-04	148.70
SLS-5504-06-06	148.70
SLS-5504-08-08	157.55
SLS-5504-12-12	243.15
SLS-5504-16-16	307.30
SLS-5504-20-20	580.85
SLS-5504-24-24	1183.60
SLS-5504-32-32	1839.10

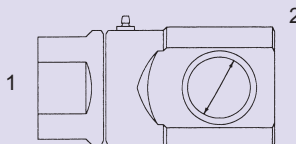

**SLS-5504-SB - 90°**  
(1) Fem. Pipe - Stem  
(2) Fem. Pipe - Barrel  
(Short Body)

SLS-5504-SB-02-02	190.70
SLS-5504-SB-04-04	162.15
SLS-5504-SB-06-06	169.00
SLS-5504-SB-08-08	169.00
SLS-5504-SB-12-12	231.55
SLS-5504-SB-16-16	287.70
SLS-5504-SB-20-20	472.00
SLS-5504-SB-24-24	1102.00
SLS-5504-SB-32-32	2163.40



# STEEL LIVE SWIVELS

Styles may vary from picture

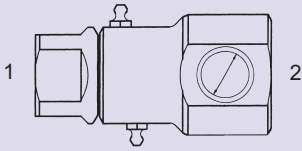

**SLS-5504-SB-HP - 90°**

High Pressure - 10,000 PSI

- (1) Fem. Pipe - Stem
- (2) Fem. Pipe - Barrel  
(Short Body)

SLS-5504-SB-HP-08-08                      582.90

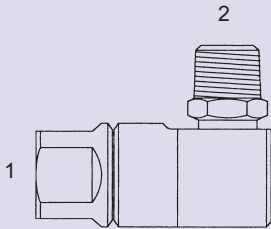

**SLS-5587 - 90°**

- (1) Fem. Pipe - Stem
- (2) Male Pipe - Barrel

SLS-5587-04-04	148.70
SLS-5587-04-06	148.70
SLS-5587-06-04	148.70
SLS-5587-06-06	148.70
SLS-5587-06-08	189.15
SLS-5587-08-06	189.15
SLS-5587-08-08	157.55
SLS-5587-12-12	243.15
SLS-5587-16-16	307.30
SLS-5587-20-20	508.70
SLS-5587-24-24	1183.60
SLS-5587-32-32	1839.10

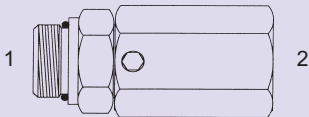

**SLS-6402-O - Str.**

- (1) Male O-Ring - Stem
- (2) Fem. JIC - Barrel

SLS-6402-06-06-O	146.40
SLS-6402-08-08-O	182.25
SLS-6402-10-10-O	160.40
SLS-6402-12-12-O	200.85
SLS-6402-16-16-O	273.45
SLS-6402-20-20-O	467.60
SLS-6402-24-24-O	1102.00

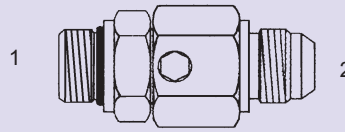

**SLS-6441-O - Str.**

- (1) Male O-Ring - Stem
- (2) Male JIC - Barrel

SLS-6441-04-04-O	266.55
SLS-6441-06-06-O	123.60
SLS-6441-08-06-O	123.60
SLS-6441-08-08-O	123.60
SLS-6441-10-08-O	143.95
SLS-6441-10-10-O	143.95
SLS-6441-10-12-O	143.95
SLS-6441-12-08-O	143.95
SLS-6441-12-12-O	144.00
SLS-6441-16-16-O	258.15
SLS-6441-20-20-O	467.60
SLS-6441-24-24-O	1079.20
SLS-6441-32-32-O	1725.70

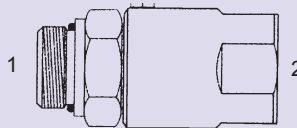

**SLS-6448-O - Str.**

- (1) Male O-Ring - Stem
- (2) Fem. Pipe - Barrel

SLS-6448-06-04-O	146.40
SLS-6448-08-06-O	151.55
SLS-6448-08-08-O	160.40
SLS-6448-10-08-O	160.40
SLS-6448-16-16-O	273.45
SLS-6448-20-20-O	467.60

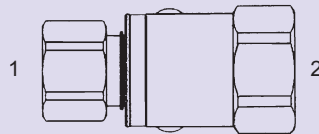

**SLS-6455 - Str.**

- (1) Fem. O-Ring - Stem
- (2) Fem. O-Ring - Barrel

SLS-6455-04-04	254.50
SLS-6455-08-08	294.75
SLS-6455-16-16	465.15

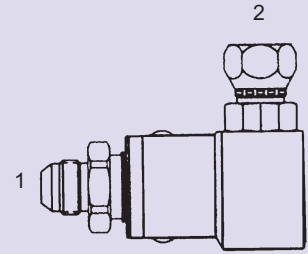

**SLS-6513 - 90°**

- (1) Male JIC Stem
- (2) Fem. JIC Swivel - Barrel

SLS-6513-06-04	167.25
SLS-6513-06-06	167.25
SLS-6513-08-06	189.15
SLS-6513-08-08	189.15
SLS-6513-12-12	482.10
SLS-6513-16-16	547.05

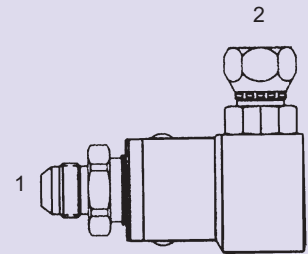

**SLS-6513-4K - 90°**

4000 PSI

- (1) Male JIC Stem
- (2) Fem. JIC Swivel - Barrel

SLS-6513-4K-08-10	189.15
SLS-6513-4K-10-10	189.15
SLS-6513-4K-12-12	255.90
SLS-6513-4K-16-16	312.40
SLS-6513-4K-20-20	508.70
SLS-6513-4K-24-24	1266.55

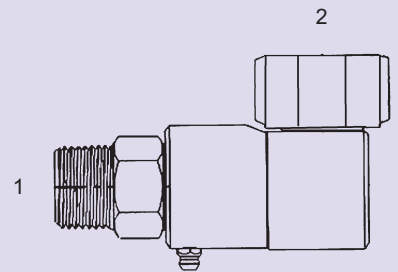

**SLS-6573 - 90°**

- (1) Male Pipe - Stem
- (2) Fem. 37° Swivel - Barrel

SLS-6573-04-04	162.15
SLS-6573-04-06	162.15
SLS-6573-06-04	167.25
SLS-6573-06-06	167.25
SLS-6573-08-08	169.00

# STEEL LIVE SWIVELS

Styles may vary from picture

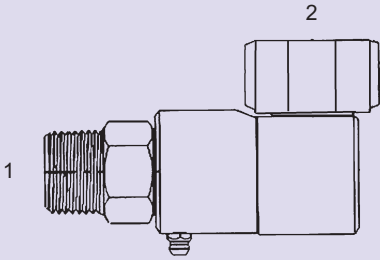

**SLS-6573-4K - 90°**  
4000 PSI  
(1) Male Pipe - Stem  
(2) Fem. 37° Swivel - Barrel

SLS-6573-4K-08-10	169.00
SLS-6573-4K-12-12	231.60
SLS-6573-4K-16-16	287.70
SLS-6573-4K-20-20	471.90
SLS-6573-4K-24-24	1102.00

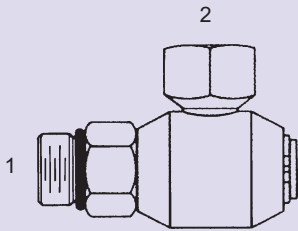

**SLS-6805-O - 90°**  
(1) Male O-Ring - Stem  
(2) Fem. Pipe - Barrel

SLS-6805-04-04-O	151.80
SLS-6805-04-06-O	148.70
SLS-6805-06-04-O	148.70
SLS-6805-06-06-O	148.70
SLS-6805-08-06-O	148.70
SLS-6805-08-08-O	157.50
SLS-6805-10-08-O	157.55
SLS-6805-12-12-O	243.15
SLS-6805-16-16-O	307.30
SLS-6805-20-20-O	580.85
SLS-6805-24-24-O	1183.55
SLS-6805-32-32-O	1841.40

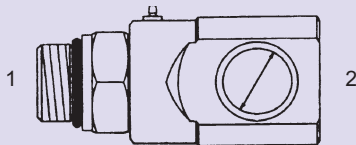

**SLS-6805-SB-O - 90°**  
(1) Male O-Ring - Stem  
(2) Fem. Pipe - Barrel  
(Short Body)

SLS-6805-SB-04-04-O	281.75
SLS-6805-SB-06-04-O	162.15
SLS-6805-SB-06-06-O	288.60
SLS-6805-SB-08-06-O	169.00
SLS-6805-SB-08-08-O	169.00
SLS-6805-SB-12-12-O	231.55
SLS-6805-SB-16-16-O	287.70
SLS-6805-SB-20-20-O	472.00
SLS-6805-SB-24-24-O	1102.00

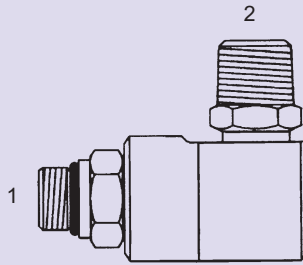

**SLS-6806-O - 90°**  
(1) Male O-Ring - Stem  
(2) Male Pipe - Barrel

SLS-6806-05-04-O	148.70
SLS-6806-05-06-O	148.70
SLS-6806-06-04-O	148.70
SLS-6806-06-06-O	148.70
SLS-6806-08-06-O	148.70
SLS-6806-08-08-O	157.50
SLS-6806-10-06-O	189.15
SLS-6806-10-08-O	157.55
SLS-6806-12-12-O	243.15
SLS-6806-16-16-O	307.30
SLS-6806-20-20-O	508.70
SLS-6806-24-24-O	1183.60
SLS-6806-32-32-O	1839.10

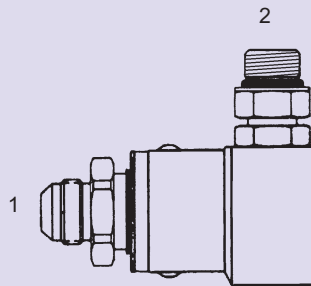

**SLS-6814-4K-O - 90°**  
4000 PSI  
(1) Male JIC - Stem  
(2) Male O-Ring - Barrel

SLS-6814-4K-12-12-O	444.90
---------------------	--------

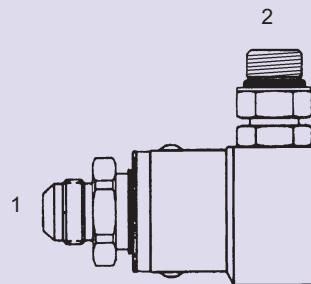

**SLS-6814-5K-O - 90°**  
5000 PSI  
(1) Male JIC - Stem  
(2) Male O-Ring - Barrel

SLS-6814-5K-04-04-O	272.85
SLS-6814-5K-08-08-O	309.50

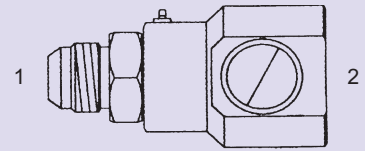

**SLS-6815-SB - 90°**  
(1) Male JIC - Stem  
(2) Fem. O-Ring - Barrel  
(Short Body)

SLS-6815-SB-06-06	162.15
SLS-6815-SB-08-08	169.00
SLS-6815-SB-10-08	169.00
SLS-6815-SB-12-12	231.55
SLS-6815-SB-16-16	287.70
SLS-6815-SB-20-20	472.00

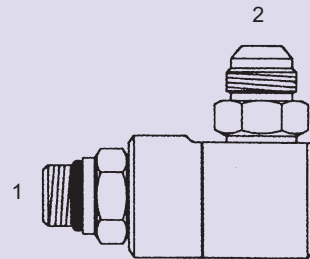

**SLS-6841-O - 90°**  
(1) Male O-Ring - Stem  
(2) Male JIC - Barrel

SLS-6841-04-04-O	151.80
SLS-6841-04-06-O	148.70
SLS-6841-05-04-O	151.80
SLS-6841-05-05-O	148.70
SLS-6841-05-06-O	148.70
SLS-6841-06-05-O	148.70
SLS-6841-06-06-O	148.70
SLS-6841-06-08-O	148.70
SLS-6841-08-05-O	148.70
SLS-6841-08-06-O	148.70
SLS-6841-08-08-O	148.70
SLS-6841-08-10-O	157.50
SLS-6841-10-06-O	189.15
SLS-6841-10-08-O	157.55
SLS-6841-10-10-O	157.55
SLS-6841-12-12-O	243.15
SLS-6841-16-16-O	307.30
SLS-6841-20-20-O	508.70
SLS-6841-24-24-O	1183.60
SLS-6841-32-32-O	1839.10

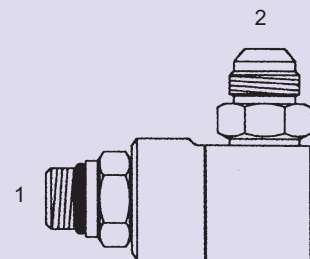

**SLS-6841-4K-O - 90°**  
4000 PSI  
(1) Male O-Ring - Stem  
(2) Male JIC - Barrel

SLS-6841-4K-12-12-O	354.10
---------------------	--------

# STEEL LIVE SWIVELS

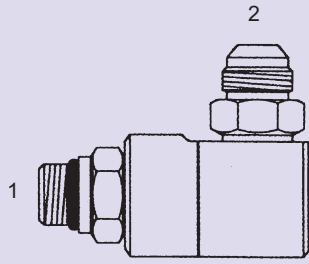

**SLS-6841-5K-O - 90°**

5000 PSI

- (1) Male O-Ring - Stem
- (2) Male JIC - Barrel

SLS-6841-5K-04-04-O	276.40
SLS-6841-5K-05-05-O	260.10
SLS-6841-5K-05-06-O	260.10
SLS-6841-5K-06-05-O	260.10
SLS-6841-5K-06-06-O	260.10
SLS-6841-5K-06-08-O	260.10
SLS-6841-5K-08-06-O	260.10
SLS-6841-5K-08-08-O	260.10
SLS-6841-5K-08-10-O	276.65
SLS-6841-5K-10-08-O	276.65
SLS-6841-5K-10-10-O	276.65
SLS-6841-5K-12-08-O	276.65

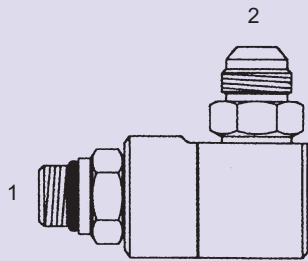

**SLS-6841-LH-O - 90°**

Large Hex

- (1) Male O-Ring - Stem
- (2) Male JIC - Barrel

SLS-6841-LH-08-08-O	157.50
---------------------	--------

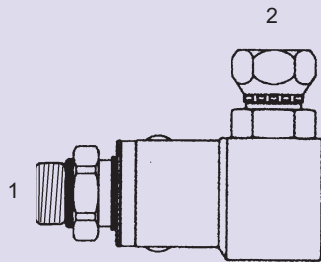

**SLS-6843-O - 90°**

- (1) Male O-Ring - Stem
- (2) Fem. JIC Swivel - Barrel

SLS-6843-06-04-O	167.25
SLS-6843-06-06-O	167.25
SLS-6843-08-06-O	189.15
SLS-6843-08-08-O	189.15

Styles may vary from picture

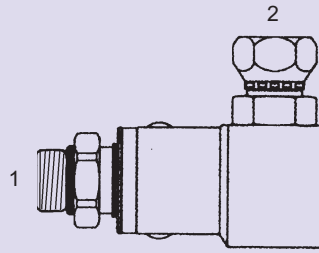

**SLS-6843-4K-O - 90°**

4000 PSI

- (1) Male O-Ring - Stem
- (2) Fem. JIC Swivel - Barrel

SLS-6843-4K-10-10-O	189.15
SLS-6843-4K-12-12-O	255.90
SLS-6843-4K-16-16-O	312.40
SLS-6843-4K-20-20-O	508.70
SLS-6843-4K-24-24-O	1266.55

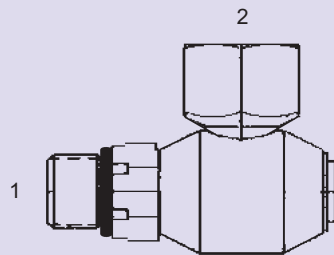

**SLS-6845-O - 90°**

- (1) Male O-Ring - Stem
- (2) Fem. O-Ring - Barrel

SLS-6845-08-08-O	148.70
------------------	--------

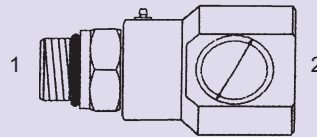

**SLS-6845-SB-O - 90°**

- (1) Male O-Ring - Stem
- (2) Fem. O-Ring - Barrel  
(Short Body)

SLS-6845-SB-04-04-O	275.90
SLS-6845-SB-06-06-O	162.15
SLS-6845-SB-08-08-O	169.00
SLS-6845-SB-10-08-O	169.00
SLS-6845-SB-12-12-O	231.55
SLS-6845-SB-16-16-O	287.70
SLS-6845-SB-20-20-O	472.00

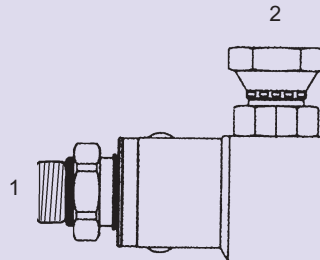

**SLS-6849-O - 90°**

- (1) Male O-Ring - Stem
- (2) Fem. Pipe Swivel - Barrel

SLS-6849-12-12-O	444.80
SLS-6849-16-16-O	542.95

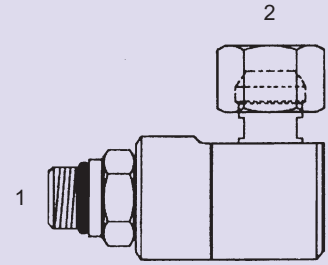

**SLS-6901-O - 90°**

- (1) Male O-Ring - Stem
- (2) Fem. Pipe Swivel - Barrel

SLS-6901-04-04-O	151.80
SLS-6901-04-06-O	148.70
SLS-6901-05-04-O	151.80
SLS-6901-06-04-O	148.70
SLS-6901-06-06-O	148.70
SLS-6901-08-06-O	148.70
SLS-6901-08-08-O	157.50
SLS-6901-10-08-O	157.55
SLS-6901-12-12-O	243.15
SLS-6901-16-16-O	307.30
SLS-6901-20-20-O	508.70
SLS-6901-24-24-O	1183.60
SLS-6901-32-32-O	1839.10

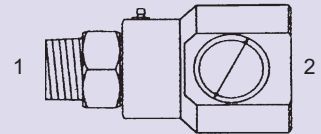

**SLS-6975-SB - 90°**

- (1) Male Pipe - Stem
- (2) Fem. O-Ring - Barrel  
(Short Body)

SLS-6975-SB-04-04	276.30
SLS-6975-SB-04-06	162.15
SLS-6975-SB-06-06	162.15
SLS-6975-SB-06-08	169.00
SLS-6975-SB-08-08	169.00
SLS-6975-SB-12-12	231.55
SLS-6975-SB-16-16	287.70
SLS-6975-SB-20-20	472.00

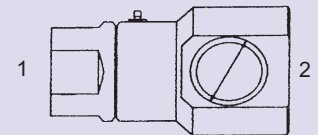

**SLS-6985-SB - 90°**

- (1) Fem. Pipe - Stem
- (2) Fem. O-Ring - Barrel

SLS-6985-SB-04-06	162.15
SLS-6985-SB-06-06	169.00
SLS-6985-SB-06-08	169.00
SLS-6985-SB-08-08	169.00
SLS-6985-SB-12-12	231.55
SLS-6985-SB-16-16	287.70
SLS-6985-SB-20-20	472.00

# STEEL LIVE SWIVELS - DUAL PLANE (90°)

Styles may vary from picture

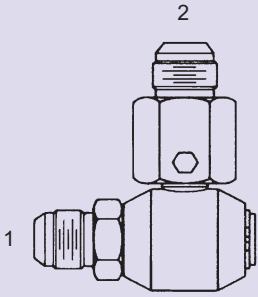

**SLS-DP-2500 - 90°**

- (1) Male JIC - Stem
- (2) Male JIC - Barrel

SLS-DP-2500-05-06	248.75
SLS-DP-2500-06-06	248.75
SLS-DP-2500-08-06	248.75
SLS-DP-2500-08-08	248.75
SLS-DP-2500-10-10	330.30
SLS-DP-2500-12-12	384.60
SLS-DP-2500-16-16	600.10
SLS-DP-2500-20-20	1095.85
SLS-DP-2500-24-24	2077.00

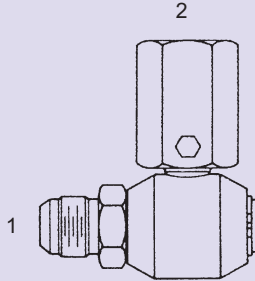

**SLS-DP-2502 - 90°**

- (1) Male JIC - Stem
- (2) Fem. Pipe - Barrel

SLS-DP-2502-05-04	248.75
SLS-DP-2502-05-06	248.75
SLS-DP-2502-06-04	248.75
SLS-DP-2502-06-06	248.75
SLS-DP-2502-08-06	248.75
SLS-DP-2502-10-08	330.30
SLS-DP-2502-12-12	384.60
SLS-DP-2502-16-16	600.10
SLS-DP-2502-20-20	1095.85
SLS-DP-2502-24-24	2077.00

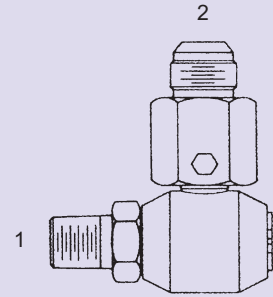

**SLS-DP-2571-4K - 90°**

4000 PSI

- (1) Male Pipe - Stem
- (2) Male JIC - Barrel

SLS-DP-2571-4K-12-12	456.85
SLS-DP-2571-4K-16-16	585.85
SLS-DP-2571-4K-20-20	894.85
SLS-DP-2571-4K-24-24	2368.55

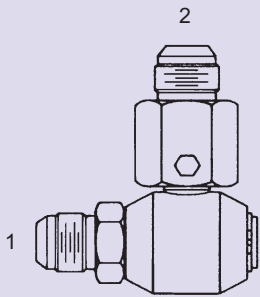

**SLS-DP-2500-4K - 90°**

4000 PSI

- (1) Male JIC - Stem
- (2) Male JIC - Barrel

SLS-DP-2500-4K-12-12	432.45
SLS-DP-2500-4K-16-16	561.25
SLS-DP-2500-4K-20-20	939.60
SLS-DP-2500-4K-24-24	2204.00

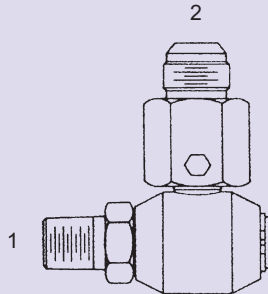

**SLS-DP-2571 - 90°**

- (1) Male Pipe - Stem
- (2) Male JIC - Barrel

SLS-DP-2571-04-06	248.75
SLS-DP-2571-06-08	248.75
SLS-DP-2571-08-08	330.30
SLS-DP-2571-08-10	330.30
SLS-DP-2571-12-12	384.60
SLS-DP-2571-16-16	600.10
SLS-DP-2571-20-20	1095.85
SLS-DP-2571-24-24	2077.00

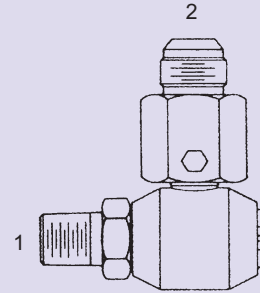

**SLS-DP-2571-5K - 90°**

5000 PSI

- (1) Male Pipe - Stem
- (2) Male JIC - Barrel

SLS-DP-2571-5K-04-04	293.85
SLS-DP-2571-5K-06-06	313.60
SLS-DP-2571-5K-08-08	349.45
SLS-DP-2571-5K-08-10	349.45

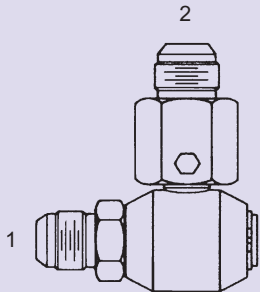

**SLS-DP-2500-5K - 90°**

5000 PSI

- (1) Male JIC - Stem
- (2) Male JIC - Barrel

SLS-DP-2500-5K-04-04	308.55
SLS-DP-2500-5K-06-06	308.55
SLS-DP-2500-5K-08-08	329.40
SLS-DP-2500-5K-10-10	329.40

# STEEL LIVE SWIVELS - DUAL PLANE (90°)

Styles may vary from picture

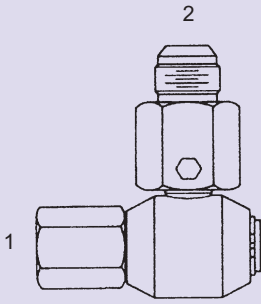

**SLS-DP-2581 - 90°**

- (1) Fem. Pipe - Stem
- (2) Male JIC - Barrel

SLS-DP-2581-04-06	248.75
SLS-DP-2581-06-06	248.75
SLS-DP-2581-06-08	248.75
SLS-DP-2581-08-10	330.30
SLS-DP-2581-12-12	384.60
SLS-DP-2581-16-16	600.10
SLS-DP-2581-20-20	1095.85
SLS-DP-2581-24-24	2077.00

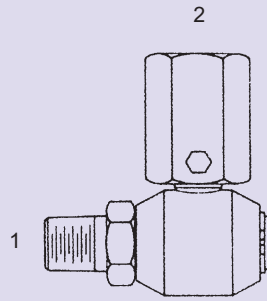

**SLS-DP-5502-5K - 90°**

5000 PSI

- (1) Male Pipe - Stem
- (2) Fem. Pipe - Barrel

SLS-DP-5502-5K-04-04	308.55
SLS-DP-5502-5K-06-06	320.55
SLS-DP-5502-5K-08-08	329.40

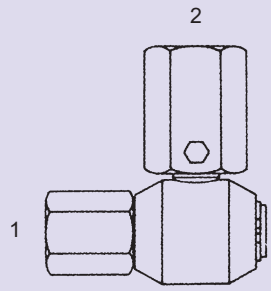

**SLS-DP-5504-5K - 90°**

5000 PSI

- (1) Fem. Pipe - Stem
- (2) Fem. Pipe - Barrel

SLS-DP-5504-5K-04-04	308.55
SLS-DP-5504-5K-06-06	320.55
SLS-DP-5504-5K-08-08	313.70

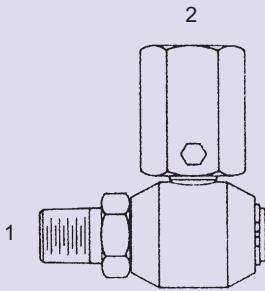

**SLS-DP-5502 - 90°**

- (1) Male Pipe - Stem
- (2) Fem. Pipe - Barrel

SLS-DP-5502-04-04	248.75
SLS-DP-5502-04-06	248.75
SLS-DP-5502-06-06	248.75
SLS-DP-5502-08-08	330.30
SLS-DP-5502-12-12	384.60
SLS-DP-5502-16-16	600.10
SLS-DP-5502-20-20	1095.85
SLS-DP-5502-24-24	2077.00

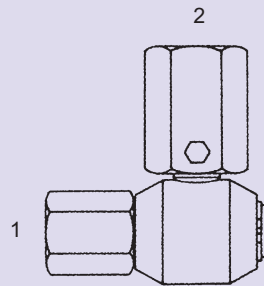

**SLS-DP-5504 - 90°**

- (1) Fem. Pipe - Stem
- (2) Fem. Pipe - Barrel

SLS-DP-5504-04-04	248.75
SLS-DP-5504-04-06	248.75
SLS-DP-5504-06-04	248.75
SLS-DP-5504-06-06	248.75
SLS-DP-5504-08-08	330.30
SLS-DP-5504-12-12	384.60
SLS-DP-5504-16-16	600.10
SLS-DP-5504-20-20	1095.85
SLS-DP-5504-24-24	2077.00

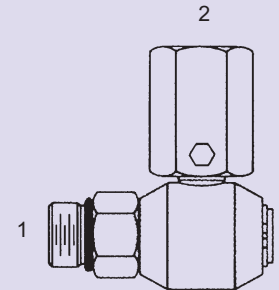

**SLS-DP-6805-O - 90°**

- (1) Male O-Ring - Stem
- (2) Fem. Pipe - Barrel

SLS-DP-6805-06-04-O	248.75
SLS-DP-6805-06-06-O	248.75
SLS-DP-6805-08-06-O	248.75
SLS-DP-6805-10-08-O	330.30
SLS-DP-6805-12-12-O	384.60
SLS-DP-6805-16-16-O	600.10
SLS-DP-6805-20-20-O	1095.85
SLS-DP-6805-24-24-O	2077.00

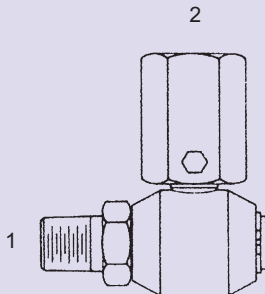

**SLS-DP-5502-4K - 90°**

4000 PSI

- (1) Male Pipe - Stem
- (2) Fem. Pipe - Barrel

SLS-DP-5502-4K-12-12	411.75
SLS-DP-5502-4K-16-16	561.25
SLS-DP-5502-4K-20-20	939.60
SLS-DP-5502-4K-24-24	2204.00

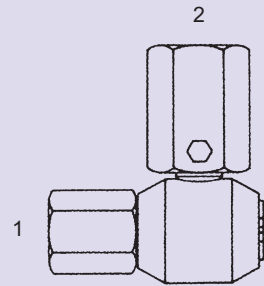

**SLS-DP-5504-4K - 90°**

4000 PSI

- (1) Fem. Pipe - Stem
- (2) Fem. Pipe - Barrel

SLS-DP-5504-4K-12-12	432.45
SLS-DP-5504-4K-16-16	561.25
SLS-DP-5504-4K-20-20	939.60
SLS-DP-5504-4K-24-24	2204.00

# STEEL LIVE SWIVELS - DUAL PLANE (90°)

Styles may vary from picture

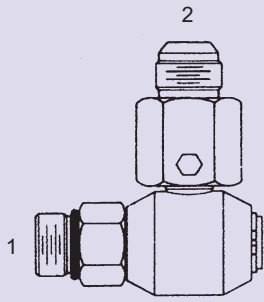

**SLS-DP-6841-O - 90°**

- (1) Male O-Ring - Stem
- (2) Male JIC - Barrel

SLS-DP-6841-06-06-O	248.75
SLS-DP-6841-08-06-O	248.75
SLS-DP-6841-08-08-O	248.75
SLS-DP-6841-10-10-O	330.30
SLS-DP-6841-12-12-O	384.60
SLS-DP-6841-16-16-O	600.10
SLS-DP-6841-20-20-O	1095.85
SLS-DP-6841-24-24-O	2077.00

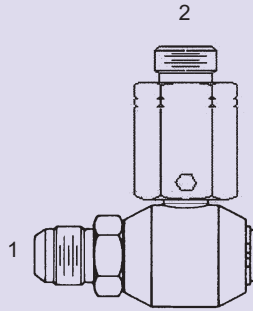

**SLS-DP-OFS-6816 - 90°**

- (1) Male JIC - Stem
- (2) Male O-Ring Face Seal - Barrel

SLS-DP-OFS-6816-06-06	292.60
SLS-DP-OFS-6816-08-08	292.60
SLS-DP-OFS-6816-10-10	388.60
SLS-DP-OFS-6816-12-12	452.50
SLS-DP-OFS-6816-16-16	705.90
SLS-DP-OFS-6816-20-20	1289.20
SLS-DP-OFS-6816-24-24	2443.55

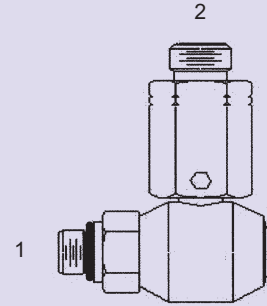

**SLS-DP-OFS-6846-4K-O - 90°**

4000 PSI

- (1) Male O-Ring - Stem
- (2) Male O-Ring Face Seal - Barrel

SLS-DP-OFS-6846-4K-12-12	432.45
SLS-DP-OFS-6846-4K-16-16	534.45
SLS-DP-OFS-6846-4K-20-20	939.60
SLS-DP-OFS-6846-4K-24-24	2204.00

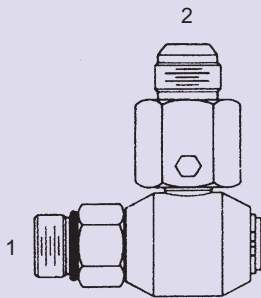

**SLS-DP-6841-4K-O - 90°**

4000 PSI

- (1) Male O-Ring - Stem
- (2) Male JIC - Barrel

SLS-DP-6841-4K-12-12-O	432.45
SLS-DP-6841-4K-16-16-O	561.25
SLS-DP-6841-4K-20-20-O	939.60
SLS-DP-6841-4K-24-24-O	2204.00

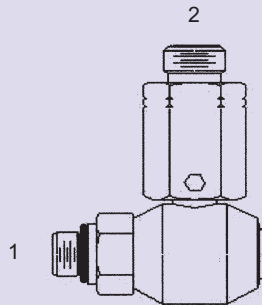

**SLS-DP-OFS-6846-O - 90°**

- (1) Male O-Ring - Stem
- (2) Male O-Ring Face Seal - Barrel

SLS-DP-OFS-6846-06-06-O	292.60
SLS-DP-OFS-6846-08-08-O	292.60
SLS-DP-OFS-6846-10-10-O	388.60
SLS-DP-OFS-6846-12-12-O	452.50
SLS-DP-OFS-6846-16-16-O	705.90
SLS-DP-OFS-6846-20-20-O	1289.20
SLS-DP-OFS-6846-24-24-O	2443.55

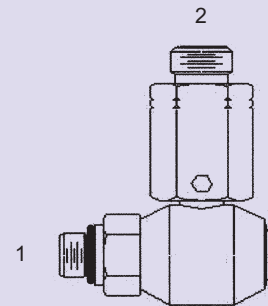

**SLS-DP-OFS-6846-5K-O - 90°**

5000 PSI

- (1) Male O-Ring - Stem
- (2) Male O-Ring Face Seal - Barrel

SLS-DP-OFS-6846-5K-06-06	308.55
SLS-DP-OFS-6846-5K-08-08	329.40
SLS-DP-OFS-6846-5K-10-10	329.40

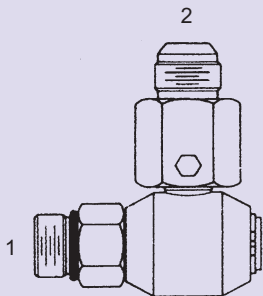

**SLS-DP-6841-5K-O - 90°**

5000 PSI

- (1) Male O-Ring - Stem
- (2) Male JIC - Barrel

SLS-DP-6841-5K-04-04-O	308.55
SLS-DP-6841-5K-06-06-O	308.55
SLS-DP-6841-5K-08-08-O	329.40
SLS-DP-6841-5K-10-10-O	329.40

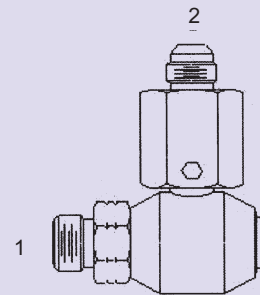

**SLS-DP-OFS-6861 - 90°**

- (1) Male O-Ring Face Seal - Stem
- (2) Male JIC - Barrel

SLS-DP-OFS-6861-06-06	292.60
SLS-DP-OFS-6861-08-08	292.60
SLS-DP-OFS-6861-10-10	388.60
SLS-DP-OFS-6861-12-12	452.50
SLS-DP-OFS-6861-16-16	705.90
SLS-DP-OFS-6861-20-20	1289.20
SLS-DP-OFS-6861-24-24	2443.55

# STEEL LIVE SWIVELS - DUAL PLANE (90°)

Styles may vary from picture

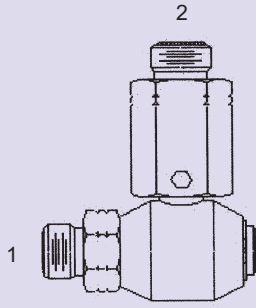

**SLS-DP-OFS-6866 - 90°**

- (1) Male O-Ring Face Seal - Stem
- (2) Male O-Ring Face Seal - Barrel

SLS-DP-OFS-6866-06-06	292.60
SLS-DP-OFS-6866-08-08	292.60
SLS-DP-OFS-6866-10-10	388.60
SLS-DP-OFS-6866-12-12	683.25
SLS-DP-OFS-6866-16-16	705.90
SLS-DP-OFS-6866-20-20	1289.20
SLS-DP-OFS-6866-24-24	2443.55

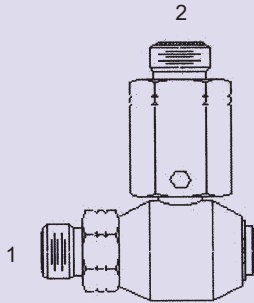

**SLS-DP-OFS-6866-4K - 90°**

- 4000 PSI
- (1) Male O-Ring Face Seal - Stem
- (2) Male O-Ring Face Seal - Barrel

SLS-DP-OFS-6866-4K-12-12	432.45
SLS-DP-OFS-6866-4K-16-16	534.45
SLS-DP-OFS-6866-4K-20-20	939.60
SLS-DP-OFS-6866-4K-24-24	2204.00

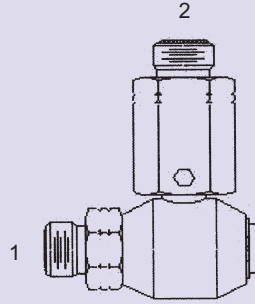

**SLS-DP-OFS-6866-5K - 90°**

- 5000 PSI
- (1) Male O-Ring Face Seal - Stem
- (2) Male O-Ring Face Seal - Barrel

SLS-DP-OFS-6866-5K-06-06	308.55
SLS-DP-OFS-6866-5K-10-10	329.40

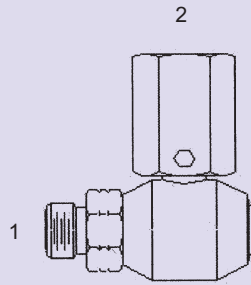

**SLS-DP-OFS-6868 - 90°**

- (1) Male O-Ring Face Seal - Stem
- (2) Female Pipe - Barrel

SLS-DP-OFS-6868-06-04	292.60
SLS-DP-OFS-6868-08-06	292.60
SLS-DP-OFS-6868-10-08	388.60
SLS-DP-OFS-6868-12-12	452.50
SLS-DP-OFS-6868-16-16	705.90
SLS-DP-OFS-6868-20-20	1289.20
SLS-DP-OFS-6868-24-24	2443.55

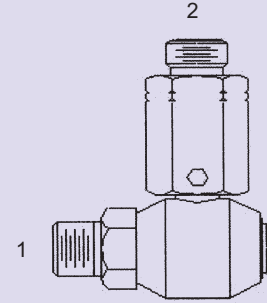

**SLS-DP-OFS-6876 - 90°**

- (1) Male Pipe - Stem
- (2) Male O-Ring Face Seal - Barrel

SLS-DP-OFS-6876-04-06	292.60
SLS-DP-OFS-6876-06-08	292.60
SLS-DP-OFS-6876-08-10	388.60
SLS-DP-OFS-6876-12-12	452.50
SLS-DP-OFS-6876-16-16	705.90
SLS-DP-OFS-6876-20-20	1289.20
SLS-DP-OFS-6876-24-24	2443.55

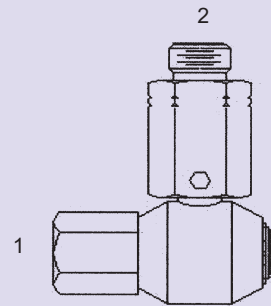

**SLS-DP-OFS-6886 - 90°**

- (1) Female Pipe - Stem
- (2) Male O-Ring Face Seal - Barrel

SLS-DP-OFS-6886-04-06	292.60
SLS-DP-OFS-6886-06-08	292.60
SLS-DP-OFS-6886-08-10	388.60
SLS-DP-OFS-6886-12-12	452.50
SLS-DP-OFS-6886-16-16	705.90
SLS-DP-OFS-6886-20-20	1289.20
SLS-DP-OFS-6886-24-24	2443.55

# STEEL LIVE SWIVELS - O-RING FACE SEAL

Styles may vary from picture

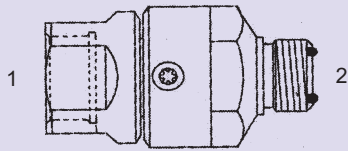

**SLS-OFS-2406 - Str.**

- (1) Fem. O-Ring Face Seal - Stem
- (2) Male O-Ring Face Seal - Barrel

SLS-OFS-2406-06-06	167.25
SLS-OFS-2406-08-08	189.15
SLS-OFS-2406-10-10	189.15
SLS-OFS-2406-12-12	255.90
SLS-OFS-2406-16-16	312.40
SLS-OFS-2406-20-20	508.60
SLS-OFS-2406-24-24	1266.55

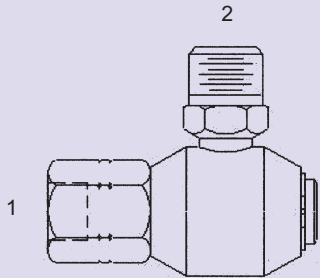

**SLS-OFS-2507 - 90°**

- (1) Fem. O-Ring Face Seal - Stem
- (2) Male Pipe - Barrel

SLS-OFS-2507-04-04	178.60
SLS-OFS-2507-06-04	174.90
SLS-OFS-2507-06-06	174.90
SLS-OFS-2507-08-04	174.90
SLS-OFS-2507-08-06	174.90
SLS-OFS-2507-08-08	185.30
SLS-OFS-2507-10-08	185.30
SLS-OFS-2507-12-12	286.10
SLS-OFS-2507-16-16	361.55
SLS-OFS-2507-20-20	683.35
SLS-OFS-2507-24-24	1392.45

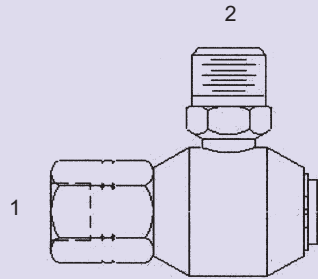

**SLS-OFS-2509 - 90°**

- (1) Fem. Pipe Swivel - Stem
- (2) Fem. O-Ring Face Seal - Barrel

SLS-OFS-2509-04-04	178.60
SLS-OFS-2509-06-04	174.90
SLS-OFS-2509-06-06	174.90
SLS-OFS-2509-08-04	174.90
SLS-OFS-2509-08-06	174.90
SLS-OFS-2509-08-08	185.30
SLS-OFS-2509-10-08	185.30
SLS-OFS-2509-12-12	286.10
SLS-OFS-2509-16-16	361.55
SLS-OFS-2509-20-20	683.35
SLS-OFS-2509-24-24	1392.45

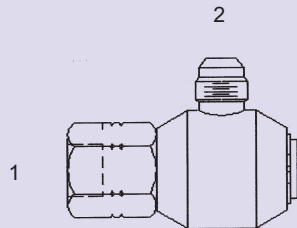

**SLS-OFS-2510 - 90°**

- (1) Fem. O-Ring Face Seal - Stem
- (2) Male JIC - Barrel

SLS-OFS-2510-04-04	178.60
SLS-OFS-2510-04-05	178.60
SLS-OFS-2510-06-05	174.90
SLS-OFS-2510-06-06	174.90
SLS-OFS-2510-06-08	174.90
SLS-OFS-2510-08-05	174.90
SLS-OFS-2510-08-06	174.90
SLS-OFS-2510-08-08	174.90
SLS-OFS-2510-08-10	185.30
SLS-OFS-2510-10-08	185.30
SLS-OFS-2510-10-10	185.30
SLS-OFS-2510-12-12	286.10
SLS-OFS-2510-16-16	361.55
SLS-OFS-2510-20-20	683.35
SLS-OFS-2510-24-24	1392.45

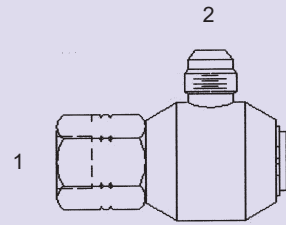

**SLS-OFS-2510-5K - 90°**  
5000 PSI

- (1) Fem. O-Ring Face Seal - Stem
- (2) Male JIC - Barrel

SLS-OFS-2510-5K-04-05	260.10
SLS-OFS-2510-5K-04-06	260.10
SLS-OFS-2510-5K-06-05	260.10
SLS-OFS-2510-5K-06-06	260.10
SLS-OFS-2510-5K-06-08	260.10
SLS-OFS-2510-5K-08-06	260.10
SLS-OFS-2510-5K-08-08	260.10
SLS-OFS-2510-5K-08-10	276.65
SLS-OFS-2510-5K-10-08	276.65
SLS-OFS-2510-5K-10-10	276.65

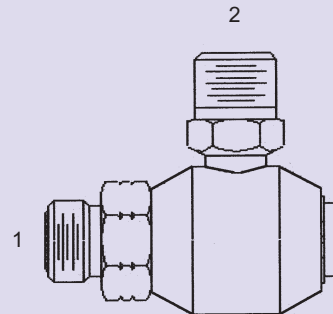

**SLS-OFS-2567 - 90°**

- (1) Male O-Ring Face Seal - Stem
- (2) Male Pipe - Barrel

SLS-OFS-2567-06-04	174.90
SLS-OFS-2567-06-06	174.90
SLS-OFS-2567-08-04	174.90
SLS-OFS-2567-08-06	174.90
SLS-OFS-2567-08-08	185.30
SLS-OFS-2567-10-08	185.30
SLS-OFS-2567-12-12	286.10
SLS-OFS-2567-16-16	361.55
SLS-OFS-2567-20-20	683.35
SLS-OFS-2567-24-24	1392.45



# STEEL LIVE SWIVELS - O-RING FACE SEAL

Styles may vary from picture

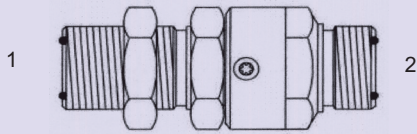

**SLS-OFS-2700-LN - Str.**

- (1) Male O-Ring Face Seal Bulkhead w/Locknut - Stem
- (2) Male O-Ring Face Seal - Barrel

SLS-OFS-2700-LN-06-06	190.00
SLS-OFS-2700-LN-08-08	214.90
SLS-OFS-2700-LN-10-10	214.90
SLS-OFS-2700-LN-12-12	276.30
SLS-OFS-2700-LN-16-16	354.90
SLS-OFS-2700-LN-20-20	566.75

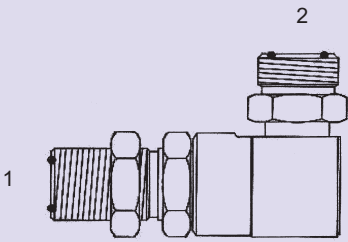

**SLS-OFS-2701-LN-4K - 90°**

4000 PSI

- (1) Male O-Ring Face Seal Bulkhead w/ Locknut - Stem
- (2) Male O-Ring Face Seal - Barrel

SLS-OFS-2701-LN-4K-12-12	276.30
SLS-OFS-2701-LN-4K-16-16	354.90
SLS-OFS-2701-LN-4K-20-20	566.75

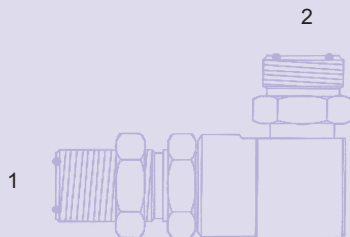

**SLS-OFS-2701-LN-5K - 90°.**

5000 PSI

- (1) Male O-Ring Face Seal Bulkhead w/ Locknut - Stem
- (2) Male O-Ring Face Seal - Barrel

SLS-OFS-2701-LN-5K-06-06	190.00
SLS-OFS-2701-LN-5K-08-08	214.90
SLS-OFS-2701-LN-5K-10-10	214.90

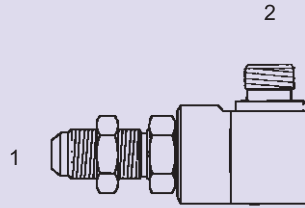

**SLS-OFS-2716-LN-4K - 90°**

4000 PSI

- (1) Male JIC - Stem
- (2) O-Ring Face Seal - Barrel

SLS-OFS-2716-LN-4K-12-12	255.90
SLS-OFS-2716-LN-4K-16-16	312.40
SLS-OFS-2716-LN-4K-20-20	508.60

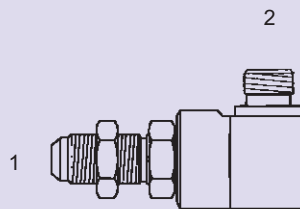

**SLS-OFS-2716-LN-5K - 90°**

5000 PSI

- (1) Male JIC - Stem
- (2) O-Ring Face Seal - Barrel

SLS-OFS-2716-LN-5K-08-06	189.15
SLS-OFS-2716-LN-5K-08-08	189.15
SLS-OFS-2716-LN-5K-08-10	189.15
SLS-OFS-2716-LN-5K-10-06	189.15
SLS-OFS-2716-LN-5K-10-08	189.15
SLS-OFS-2716-LN-5K-10-10	189.15

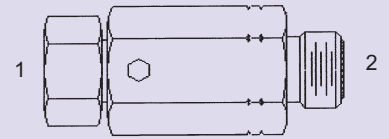

**SLS-OFS-6426 - Str.**

- (1) Fem. JIC - Stem
- (2) Male O-Ring Face Seal - Barrel

SLS-OFS-6426-06-06	145.40
SLS-OFS-6426-08-08	145.40
SLS-OFS-6426-10-10	169.40
SLS-OFS-6426-12-12	169.40
SLS-OFS-6426-16-16	303.70
SLS-OFS-6426-20-20	566.40
SLS-OFS-6426-24-24	1269.65

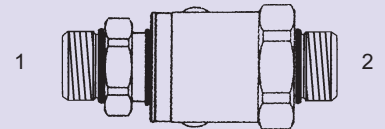

**SLS-OFS-6446-O - Str.**

- (1) Male O-Ring - Stem
- (2) Male O-Ring Face Seal - Barrel

SLS-OFS-6446-06-06-O	145.40
SLS-OFS-6446-08-06-O	145.40
SLS-OFS-6446-08-10-O	169.40
SLS-OFS-6446-10-10-O	169.40
SLS-OFS-6446-12-12-O	169.40
SLS-OFS-6446-16-16-O	303.70
SLS-OFS-6446-20-20-O	566.40
SLS-OFS-6446-24-24-O	1269.65

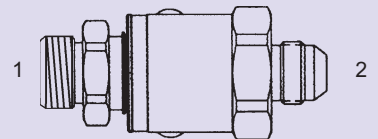

**SLS-OFS-6461 - Str.**

- (1) Male O-Ring Face Seal - Stem
- (2) Male JIC - Barrel

SLS-OFS-6461-06-06	145.40
SLS-OFS-6461-08-08	145.40
SLS-OFS-6461-12-12	169.40
SLS-OFS-6461-16-16	303.70
SLS-OFS-6461-20-20	566.40
SLS-OFS-6461-24-24	1269.65

# STEEL LIVE SWIVELS - O-RING FACE SEAL

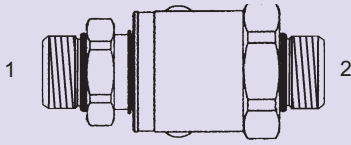

## SLS-OFS-6466 - Str.

- (1) Male O-Ring Face Seal - Stem
- (2) Male O-Ring Face Seal - Barrel

SLS-OFS-6466-06-06	145.40
SLS-OFS-6466-08-08	145.40
SLS-OFS-6466-10-10	169.40
SLS-OFS-6466-12-12	169.40
SLS-OFS-6466-16-16	303.70
SLS-OFS-6466-20-20	566.45
SLS-OFS-6466-24-24	1269.65

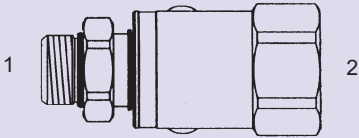

## SLS-OFS-6468 - Str.

- (1) Male O-Ring Face Seal - Stem
- (2) Fem. Pipe - Barrel

SLS-OFS-6468-06-04	145.40
SLS-OFS-6468-08-06	145.40
SLS-OFS-6468-10-08	169.40
SLS-OFS-6468-12-12	169.40
SLS-OFS-6468-16-16	303.70
SLS-OFS-6468-20-20	566.40
SLS-OFS-6468-24-24	1269.65

Styles may vary from picture

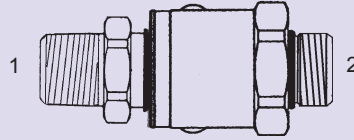

## SLS-OFS-6476 - Str.

- (1) Male Pipe - Stem
- (2) Male O-Ring Face Seal - Barrel

SLS-OFS-6476-04-06	145.40
SLS-OFS-6476-06-08	145.40
SLS-OFS-6476-12-12	169.40
SLS-OFS-6476-16-16	303.70
SLS-OFS-6476-20-20	566.40
SLS-OFS-6476-24-24	1269.65

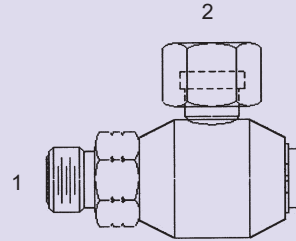

## SLS-OFS-6500 - 90°

- (1) Male O-Ring Face Seal - Stem
- (2) Fem. O-Ring Face Seal Swivel - Barrel

SLS-OFS-6500-06-06	174.90
SLS-OFS-6500-08-06	174.90
SLS-OFS-6500-08-08	185.30
SLS-OFS-6500-08-10	185.30
SLS-OFS-6500-10-08	185.30
SLS-OFS-6500-10-10	185.30
SLS-OFS-6500-12-12	286.10
SLS-OFS-6500-16-16	361.55
SLS-OFS-6500-20-20	683.35
SLS-OFS-6500-24-24	1392.45

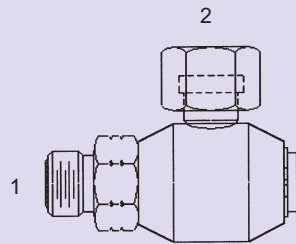

## SLS-OFS-6500-5K - 90°

5000 PSI

- (1) Male O-Ring Face Seal - Stem
- (2) Fem. O-Ring Face Seal Swivel - Barrel

SLS-OFS-6500-5K-04-06	260.10
SLS-OFS-6500-5K-06-06	260.10
SLS-OFS-6500-5K-06-08	260.10
SLS-OFS-6500-5K-08-06	260.10
SLS-OFS-6500-5K-08-08	260.10
SLS-OFS-6500-5K-08-10	276.65
SLS-OFS-6500-5K-10-08	276.65
SLS-OFS-6500-5K-10-10	276.65

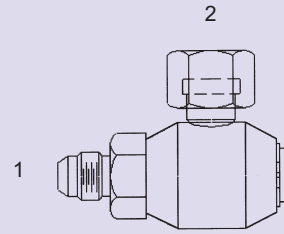

## SLS-OFS-6510 - 90°

- (1) Male JIC - Stem
- (2) Fem. O-Ring Face Seal Swivel - Barrel

SLS-OFS-6510-05-06	174.90
SLS-OFS-6510-06-06	174.90
SLS-OFS-6510-08-06	174.90
SLS-OFS-6510-08-08	185.30
SLS-OFS-6510-08-10	185.30
SLS-OFS-6510-10-08	185.30
SLS-OFS-6510-10-10	185.30
SLS-OFS-6510-12-12	286.10
SLS-OFS-6510-16-16	361.55
SLS-OFS-6510-20-20	683.35
SLS-OFS-6510-24-24	1392.45

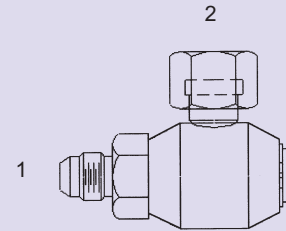

## SLS-OFS-6510-5K - 90°

5000 PSI

- (1) Male JIC - Stem
- (2) Fem. O-Ring Face Seal Swivel - Barrel

SLS-OFS-6510-5K-05-06	260.10
SLS-OFS-6510-5K-06-06	260.10
SLS-OFS-6510-5K-06-08	260.10
SLS-OFS-6510-5K-08-06	260.10
SLS-OFS-6510-5K-08-08	260.10
SLS-OFS-6510-5K-08-10	276.65
SLS-OFS-6510-5K-10-08	276.65
SLS-OFS-6510-5K-10-10	276.65

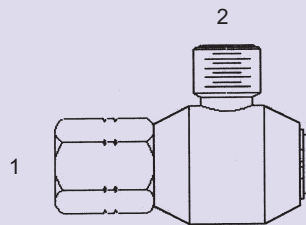

## SLS-OFS-6560 - 90°

- (1) Fem. O-Ring Face Seal - Stem
- (2) Male O-Ring Face Seal - Barrel

SLS-OFS-6560-04-04	178.60
SLS-OFS-6560-06-06	174.90
SLS-OFS-6560-08-08	174.90
SLS-OFS-6560-10-10	185.30
SLS-OFS-6560-12-12	286.10
SLS-OFS-6560-16-16	361.55
SLS-OFS-6560-20-20	683.35
SLS-OFS-6560-24-24	1392.45

# STEEL LIVE SWIVELS - O-RING FACE SEAL

Styles may vary from picture

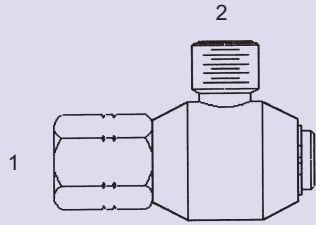

**SLS-OFS-6560-4K - 90°**

4000 PSI

- (1) Fem. O-Ring Face Seal - Stem
- (2) Male O-Ring Face Seal - Barrel

SLS-OFS-6560-4K-12-12	255.90
SLS-OFS-6560-4K-16-16	312.40
SLS-OFS-6560-4K-20-20	508.60
SLS-OFS-6560-4K-24-24	1266.55

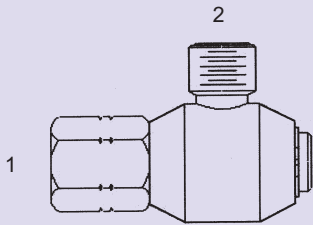

**SLS-OFS-6560-5K - 90°**

5000 PSI

- (1) Fem. O-Ring Face Seal - Stem
- (2) Male O-Ring Face Seal - Barrel

SLS-OFS-6560-5K-04-04	167.25
SLS-OFS-6560-5K-04-06	260.10
SLS-OFS-6560-5K-06-04	260.10
SLS-OFS-6560-5K-06-06	260.10
SLS-OFS-6560-5K-06-08	260.10
SLS-OFS-6560-5K-08-06	260.10
SLS-OFS-6560-5K-08-08	189.15
SLS-OFS-6560-5K-08-10	276.65
SLS-OFS-6560-5K-10-08	276.65
SLS-OFS-6560-5K-10-10	189.15

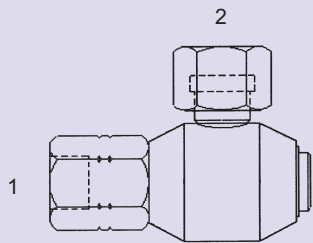

**SLS-OFS-6565 - 90°**

- (1) Fem. O-Ring Face Seal - Stem
- (2) Male O-Ring Face Seal Swivel - Barrel

SLS-OFS-6565-06-06	174.90
SLS-OFS-6565-08-06	174.90
SLS-OFS-6565-08-08	185.30
SLS-OFS-6565-08-10	185.30
SLS-OFS-6565-10-10	185.30
SLS-OFS-6565-12-12	286.10
SLS-OFS-6565-16-16	361.55
SLS-OFS-6565-20-20	683.35
SLS-OFS-6565-24-24	1392.45

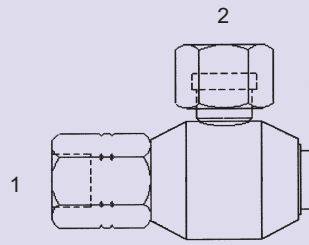

**SLS-OFS-6565-5K - 90°**

5000 PSI

- (1) Fem. O-Ring Face Seal - Stem
- (2) Male O-Ring Face Seal Swivel - Barrel

SLS-OFS-6565-5K-04-06	260.10
SLS-OFS-6565-5K-06-06	260.10
SLS-OFS-6565-5K-06-08	260.10
SLS-OFS-6565-5K-08-06	260.10
SLS-OFS-6565-5K-08-08	260.10
SLS-OFS-6565-5K-08-10	276.65
SLS-OFS-6565-5K-10-08	276.65
SLS-OFS-6565-5K-10-10	276.65

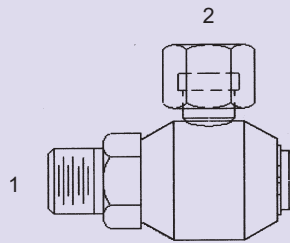

**SLS-OFS-6570 - 90°**

- (1) Male Pipe - Stem
- (2) Fem. O-Ring Face Seal Swivel - Barrel

SLS-OFS-6570-04-04	178.60
SLS-OFS-6570-04-06	174.90
SLS-OFS-6570-06-06	174.90
SLS-OFS-6570-08-08	185.30
SLS-OFS-6570-08-10	185.30
SLS-OFS-6570-12-12	286.10
SLS-OFS-6570-16-16	361.55
SLS-OFS-6570-20-20	683.35
SLS-OFS-6570-24-24	1392.45

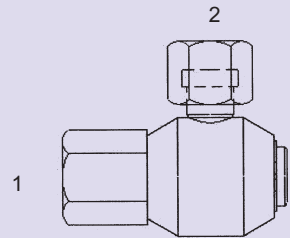

**SLS-OFS-6580 - 90°**

- (1) Fem. Pipe - Stem
- (2) Fem. O-Ring Face Seal Swivel - Barrel

SLS-OFS-6580-04-06	174.90
SLS-OFS-6580-06-06	174.90
SLS-OFS-6580-08-08	185.30
SLS-OFS-6580-08-10	185.30
SLS-OFS-6580-12-12	286.10
SLS-OFS-6580-16-16	361.55
SLS-OFS-6580-20-20	683.35
SLS-OFS-6580-24-24	1392.45

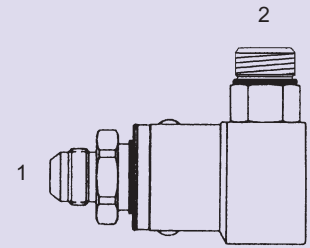

**SLS-OFS-6816 - 90°**

- (1) Male JIC - Stem
- (2) Male O-Ring Face Seal - Barrel

SLS-OFS-6816-06-06	174.90
SLS-OFS-6816-08-08	174.90
SLS-OFS-6816-10-10	185.30
SLS-OFS-6816-12-12	286.10
SLS-OFS-6816-16-16	361.55
SLS-OFS-6816-20-20	683.35
SLS-OFS-6816-24-24	1392.45

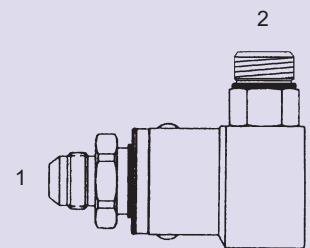

**SLS-OFS-6816-4K - 90°**

4000 PSI

- (1) Male JIC - Stem
- (2) Male O-Ring Face Seal - Barrel

SLS-OFS-6816-4K-12-12	255.90
SLS-OFS-6816-4K-16-16	312.40
SLS-OFS-6816-4K-20-20	508.60
SLS-OFS-6816-4K-24-24	1266.55

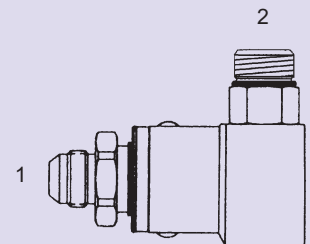

**SLS-OFS-6816-5K - 90°**

5000 PSI

- (1) Male JIC - Stem
- (2) Male O-Ring Face Seal - Barrel

SLS-OFS-6816-5K-05-04	260.10
SLS-OFS-6816-5K-05-06	260.10
SLS-OFS-6816-5K-06-04	260.10
SLS-OFS-6816-5K-06-06	167.25
SLS-OFS-6816-5K-06-08	260.10
SLS-OFS-6816-5K-08-06	189.15
SLS-OFS-6816-5K-08-08	189.15
SLS-OFS-6816-5K-08-10	189.15
SLS-OFS-6816-5K-10-08	189.15
SLS-OFS-6816-5K-10-10	189.15

# STEEL LIVE SWIVELS - O-RING FACE SEAL

Styles may vary from picture

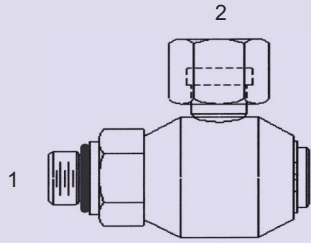

**SLS-OFS-6840-O - 90°**

- (1) Male O-Ring - Stem
- (2) Fem. O-Ring Face Seal Swivel - Barrel

SLS-OFS-6840-04-06-O	174.90
SLS-OFS-6840-05-06-O	174.90
SLS-OFS-6840-06-06-O	174.90
SLS-OFS-6840-08-06-O	174.90
SLS-OFS-6840-08-08-O	185.30
SLS-OFS-6840-08-10-O	185.30
SLS-OFS-6840-10-08-O	185.30
SLS-OFS-6840-10-10-O	185.30
SLS-OFS-6840-12-08-O	185.30
SLS-OFS-6840-12-10-O	185.30
SLS-OFS-6840-12-12-O	286.10
SLS-OFS-6840-16-16-O	361.55
SLS-OFS-6840-20-20-O	683.35
SLS-OFS-6840-24-24-O	1392.45

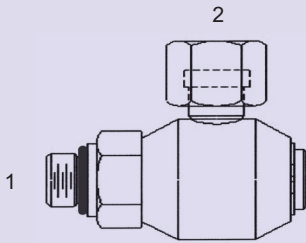

**SLS-OFS-6840-5K-O - 90°**

5000 PSI

- (1) Male O-Ring - Stem
- (2) Fem. O-Ring Face Seal Swivel - Barrel

SLS-OFS-6840-5K-05-06-O	260.10
SLS-OFS-6840-5K-06-06-O	260.10
SLS-OFS-6840-5K-06-08-O	260.10
SLS-OFS-6840-5K-08-06-O	260.10
SLS-OFS-6840-5K-08-08-O	260.10
SLS-OFS-6840-5K-08-10-O	276.65
SLS-OFS-6840-5K-10-08-O	276.65
SLS-OFS-6840-5K-10-10-O	276.65

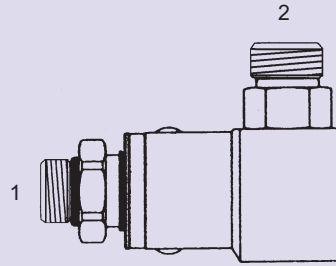

**SLS-OFS-6846-O - 90°**

- (1) Male O-Ring - Stem
- (2) Male O-Ring Face Seal - Barrel

SLS-OFS-6846-04-04-O	178.60
SLS-OFS-6846-04-06-O	174.90
SLS-OFS-6846-05-08-O	174.90
SLS-OFS-6846-06-04-O	174.90
SLS-OFS-6846-06-06-O	174.90
SLS-OFS-6846-06-08-O	174.90
SLS-OFS-6846-08-06-O	174.90
SLS-OFS-6846-08-08-O	174.90
SLS-OFS-6846-08-10-O	185.30
SLS-OFS-6846-10-08-O	185.30
SLS-OFS-6846-10-10-O	185.30
SLS-OFS-6846-12-08-O	185.30
SLS-OFS-6846-12-10-O	185.30
SLS-OFS-6846-12-12-O	286.10
SLS-OFS-6846-16-16-O	361.55
SLS-OFS-6846-20-20-O	683.35
SLS-OFS-6846-24-24-O	1392.45

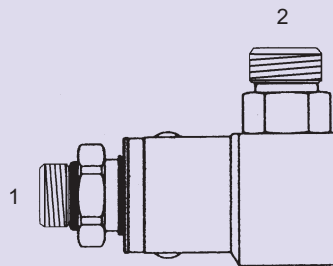

**SLS-OFS-6846-4K-O - 90°**

4000 PSI

- (1) Male O-Ring - Stem
- (2) Male O-Ring Face Seal - Barrel

SLS-OFS-6846-4K-12-12-O	255.90
SLS-OFS-6846-4K-16-16-O	312.40
SLS-OFS-6846-4K-20-20-O	508.60
SLS-OFS-6846-4K-24-24-O	1266.55

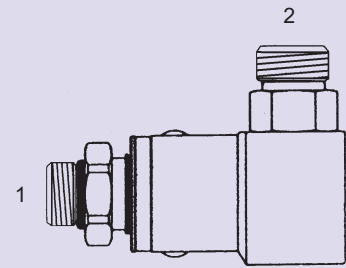

**SLS-OFS-6846-5K-O - 90°**

5000 PSI

- (1) Male O-Ring - Stem
- (2) Male O-Ring Face Seal - Barrel

SLS-OFS-6846-5K-05-04-O	260.10
SLS-OFS-6846-5K-05-06-O	260.10
SLS-OFS-6846-5K-06-04-O	260.10
SLS-OFS-6846-5K-06-06-O	167.25
SLS-OFS-6846-5K-06-08-O	260.10
SLS-OFS-6846-5K-08-06-O	189.15
SLS-OFS-6846-5K-08-08-O	189.15
SLS-OFS-6846-5K-08-10-O	189.15
SLS-OFS-6846-5K-10-08-O	189.15
SLS-OFS-6846-5K-10-10-O	189.15

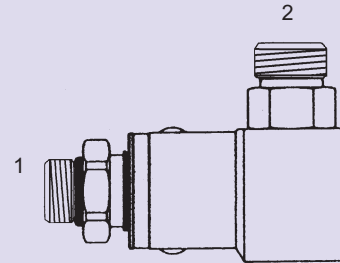

**SLS-OFS-6846-LH - 90°**

5000 PSI

Large Hex

- (1) Male O-Ring - Stem
- (2) Male O-Ring Face Seal - Barrel

SLS-OFS-6846-LH-08-08-O	185.30
-------------------------	--------

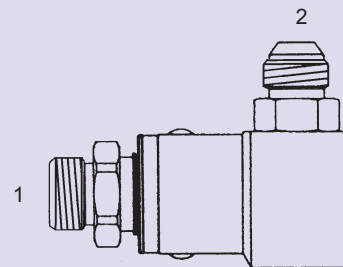

**SLS-OFS-6861 - 90°**

(1) Male O-Ring Face Seal - Stem

(2) Male JIC - Barrel

SLS-OFS-6861-06-05	174.90
SLS-OFS-6861-06-06	174.90
SLS-OFS-6861-06-08	174.90
SLS-OFS-6861-08-06	174.90
SLS-OFS-6861-08-08	174.90
SLS-OFS-6861-08-10	185.30
SLS-OFS-6861-10-10	185.30
SLS-OFS-6861-12-12	286.10
SLS-OFS-6861-16-16	361.55
SLS-OFS-6861-20-20	683.35
SLS-OFS-6861-24-24	1392.45

# STEEL LIVE SWIVELS - O-RING FACE SEAL

Styles may vary from picture

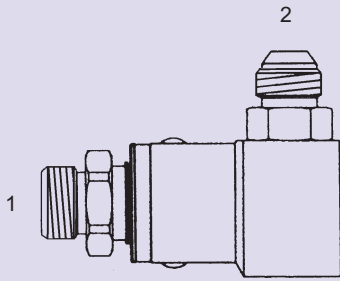

## SLS-OFS-6861-5K - 90°

5000 PSI

- (1) Male O-Ring Face Seal - Stem
- (2) Male JIC - Barrel

SLS-OFS-6861-5K-04-05	260.10
SLS-OFS-6861-5K-04-06	260.10
SLS-OFS-6861-5K-06-05	260.10
SLS-OFS-6861-5K-06-06	260.10
SLS-OFS-6861-5K-06-08	260.10
SLS-OFS-6861-5K-06-08	260.10
SLS-OFS-6861-5K-08-06	260.10
SLS-OFS-6861-5K-08-08	260.10
SLS-OFS-6861-5K-08-10	276.65
SLS-OFS-6861-5K-10-08	276.65
SLS-OFS-6861-5K-10-10	276.65

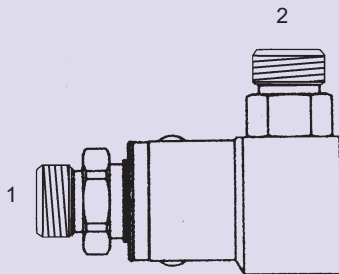

## SLS-OFS-6866 - 90°

- (1) Male O-Ring Face Seal - Stem
- (2) Male O-Ring Face Seal - Barrel

SLS-OFS-6866-04-04	178.60
SLS-OFS-6866-06-06	174.90
SLS-OFS-6866-06-08	174.90
SLS-OFS-6866-08-06	174.90
SLS-OFS-6866-08-08	174.90
SLS-OFS-6866-08-10	185.30
SLS-OFS-6866-10-10	185.30
SLS-OFS-6866-12-12	286.10
SLS-OFS-6866-16-16	361.55
SLS-OFS-6866-20-20	683.35
SLS-OFS-6866-24-24	1392.45

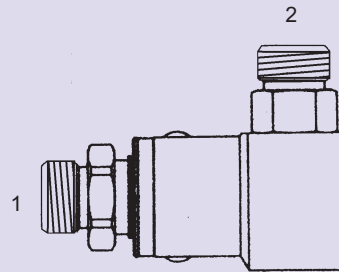

## SLS-OFS-6866-4K - 90°

4000 PSI

- (1) Male O-Ring Face Seal - Stem
- (2) Male O-Ring Face Seal - Barrel

SLS-OFS-6866-4K-12-12	255.90
SLS-OFS-6866-4K-16-16	312.40
SLS-OFS-6866-4K-20-20	508.60
SLS-OFS-6866-4K-24-24	1266.55

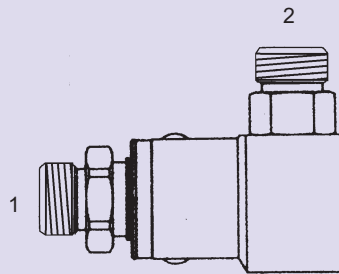

## SLS-OFS-6866-5K - 90°

5000 PSI

- (1) Male O-Ring Face Seal - Stem
- (2) Male O-Ring Face Seal - Barrel

SLS-OFS-6866-5K-04-04	260.10
SLS-OFS-6866-5K-04-06	260.10
SLS-OFS-6866-5K-06-04	260.10
SLS-OFS-6866-5K-06-06	167.25
SLS-OFS-6866-5K-06-08	260.10
SLS-OFS-6866-5K-08-06	260.10
SLS-OFS-6866-5K-08-08	189.15
SLS-OFS-6866-5K-08-10	276.65
SLS-OFS-6866-5K-10-08	276.65
SLS-OFS-6866-5K-10-10	189.15

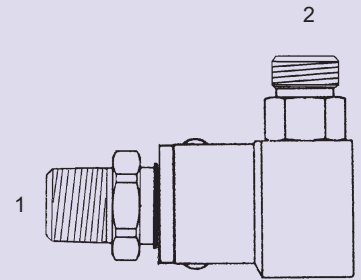

## SLS-OFS-6876 - 90°

- (1) Male Pipe - Stem
- (2) Male O-Ring Face Seal - Barrel

SLS-OFS-6876-04-04	178.60
SLS-OFS-6876-04-06	174.90
SLS-OFS-6876-06-06	174.90
SLS-OFS-6876-06-08	174.90
SLS-OFS-6876-08-08	185.30
SLS-OFS-6876-08-10	185.30
SLS-OFS-6876-12-12	286.10
SLS-OFS-6876-16-16	361.55
SLS-OFS-6876-20-20	683.35
SLS-OFS-6876-24-24	1392.45

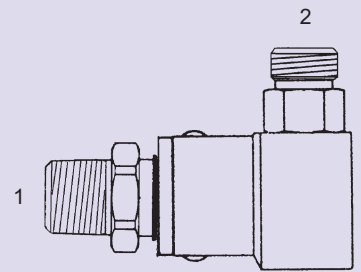

## SLS-OFS-6876-4K - 90°

4000 PSI

- (1) Male Pipe - Stem
- (2) Male O-Ring Face Seal - Barrel

SLS-OFS-6876-4K-12-12	255.90
SLS-OFS-6876-4K-16-16	312.40
SLS-OFS-6876-4K-20-20	508.60
SLS-OFS-6876-4K-24-24	1266.55

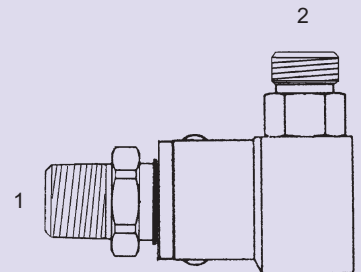

## SLS-OFS-6876-5K - 90°

5000 PSI

- (1) Male Pipe - Stem
- (2) Male O-Ring Face Seal - Barrel

SLS-OFS-6876-5K-04-04	167.25
SLS-OFS-6876-5K-06-06	167.25
SLS-OFS-6876-5K-06-08	189.15
SLS-OFS-6876-5K-08-08	189.15
SLS-OFS-6876-5K-08-10	189.15

# STEEL LIVE SWIVELS - O-RING FACE SEAL

Styles may vary from picture

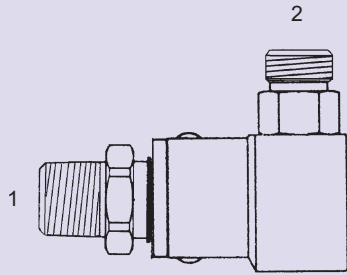

**SLS-OFS-6876-5K-LH - 90°**

5000 PSI  
Large Hex

- (1) Male Pipe - Stem
- (2) Male O-Ring Face Seal - Barrel

SLS-OFS-6876-5K-LH-06-06 189.15

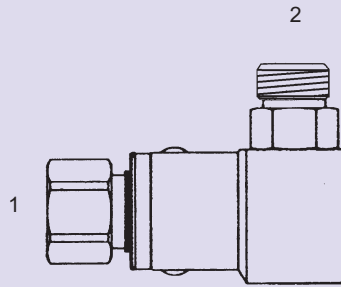

**SLS-OFS-6886-4K - 90°**

4000 PSI

- (1) Fem. Pipe - Stem
- (2) Male O-Ring Face Seal - Barrel

SLS-OFS-6886-4K-12-12 255.90

SLS-OFS-6886-4K-16-16 312.40

SLS-OFS-6886-4K-20-20 471.90

SLS-OFS-6886-4K-24-24 1266.55

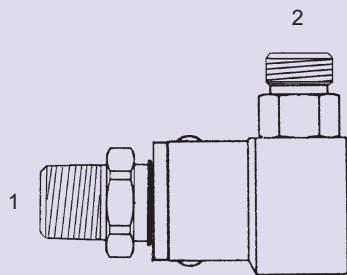

**SLS-OFS-6876-LH - 90°**

Large Hex

- (1) Male Pipe - Stem
- (2) Male O-Ring Face Seal - Barrel

SLS-OFS-6876-LH-06-06 189.15

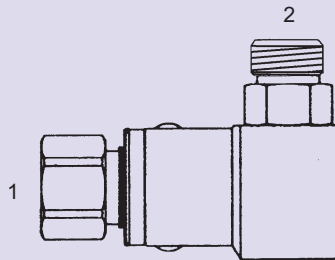

**SLS-OFS-6886-5K - 90°**

5000 PSI

- (1) Fem. Pipe - Stem
- (2) Male O-Ring Face Seal - Barrel

SLS-OFS-6886-5K-04-06 167.25

SLS-OFS-6886-5K-06-06 189.15

SLS-OFS-6886-5K-06-08 189.15

SLS-OFS-6886-5K-08-08 189.15

SLS-OFS-6886-5K-08-10 189.15

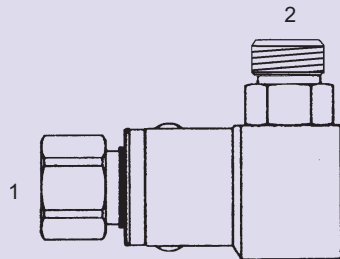

**SLS-OFS-6886 - 90°**

- (1) Fem. Pipe - Stem
- (2) Male O-Ring Face Seal - Barrel

SLS-OFS-6886-04-06 174.90

SLS-OFS-6886-06-06 174.90

SLS-OFS-6886-06-08 174.90

SLS-OFS-6886-08-08 185.30

SLS-OFS-6886-08-10 185.30

SLS-OFS-6886-12-12 286.10

SLS-OFS-6886-16-16 361.55

SLS-OFS-6886-20-20 683.35

SLS-OFS-6886-24-24 1392.45

# STEEL LIVE SWIVELS -PARALLEL PLANE (180° 3000 PSI)

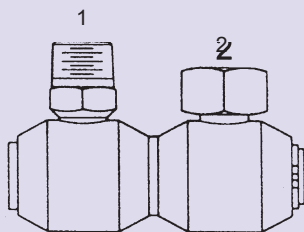

### SLS-PP-1404

(1) Male Pipe - Stem  
(2) Fem. Pipe Swivel - Barrel

SLS-PP-1404-04-04	296.40
SLS-PP-1404-04-06	296.40
SLS-PP-1404-06-04	296.40
SLS-PP-1404-06-06	296.40
SLS-PP-1404-08-08	309.10
SLS-PP-1404-12-12	512.25
SLS-PP-1404-16-16	668.75
SLS-PP-1404-20-20	1136.25
SLS-PP-1404-24-24	2664.75
SLS-PP-1404-32-32	3908.70

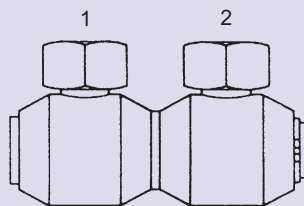

### SLS-PP-1406

(1) (2) Fem. Pipe Swivel

SLS-PP-1406-04-04	296.40
SLS-PP-1406-06-06	296.40
SLS-PP-1406-08-08	309.10
SLS-PP-1406-12-12	512.25
SLS-PP-1406-16-16	668.75
SLS-PP-1406-20-20	1136.25
SLS-PP-1406-24-24	2664.75
SLS-PP-1406-32-32	3908.70

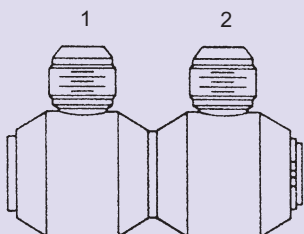

### SLS-PP-2403

(1) (2) Male JIC

SLS-PP-2403-05-05	296.40
SLS-PP-2403-06-06	296.40
SLS-PP-2403-08-08	296.40
SLS-PP-2403-10-08	309.10
SLS-PP-2403-10-10	309.10
SLS-PP-2403-12-12	512.25
SLS-PP-2403-16-16	668.75
SLS-PP-2403-20-20	1136.25
SLS-PP-2403-24-24	2664.75
SLS-PP-2403-32-32	3908.70

Styles may vary from picture

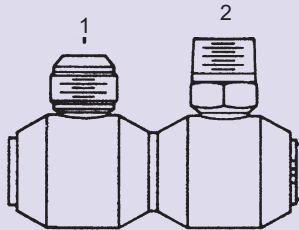

### SLS-PP-2404

(1) Male JIC  
(2) Male Pipe

SLS-PP-2404-05-04	296.40
SLS-PP-2404-06-04	296.40
SLS-PP-2404-06-06	296.40
SLS-PP-2404-08-04	296.40
SLS-PP-2404-08-06	296.40
SLS-PP-2404-08-08	309.10
SLS-PP-2404-10-08	309.10
SLS-PP-2404-12-12	512.25
SLS-PP-2404-16-16	668.75
SLS-PP-2404-20-20	1136.25
SLS-PP-2404-24-24	2664.75
SLS-PP-2404-32-32	3908.70

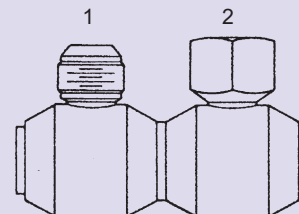

### SLS-PP-2405

(1) Male JIC  
(2) Fem. Pipe

SLS-PP-2405-05-04	296.40
SLS-PP-2405-05-06	296.40
SLS-PP-2405-06-04	296.40
SLS-PP-2405-06-06	296.40
SLS-PP-2405-08-06	296.40
SLS-PP-2405-08-08	309.10
SLS-PP-2405-10-08	309.10
SLS-PP-2405-12-12	512.25
SLS-PP-2405-16-16	668.75
SLS-PP-2405-20-20	1136.25
SLS-PP-2405-24-24	2664.75
SLS-PP-2405-32-32	3908.70

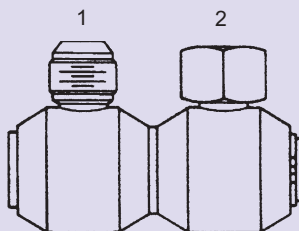

### SLS-PP-2800

(1) Male JIC  
(2) Fem. Pipe Swivel

SLS-PP-2800-05-04	296.40
SLS-PP-2800-05-06	296.40
SLS-PP-2800-06-04	296.40
SLS-PP-2800-06-06	296.40
SLS-PP-2800-08-06	296.40
SLS-PP-2800-08-08	309.10

SLS-PP-2800-10-08	309.10
SLS-PP-2800-12-12	512.25
SLS-PP-2800-16-16	668.75
SLS-PP-2800-20-20	1136.25
SLS-PP-2800-24-24	2664.75
SLS-PP-2800-32-32	3908.70

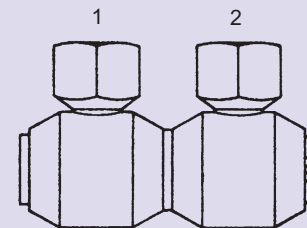

### SLS-PP-5000

(1) Fem. Pipe  
(2) Fem. Pipe

SLS-PP-5000-04-04	296.40
SLS-PP-5000-06-06	296.40
SLS-PP-5000-08-08	309.10
SLS-PP-5000-12-12	512.25
SLS-PP-5000-16-16	668.75
SLS-PP-5000-20-20	1136.25
SLS-PP-5000-24-24	2664.75
SLS-PP-5000-32-32	3908.70

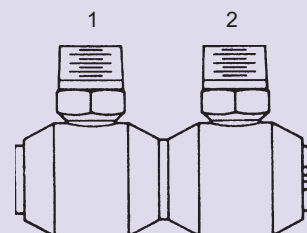

### SLS-PP-5404

(1) (2) Male Pipe

SLS-PP-5404-04-04	296.40
SLS-PP-5404-06-06	296.40
SLS-PP-5404-08-08	309.10
SLS-PP-5404-12-12	512.25
SLS-PP-5404-16-16	668.75
SLS-PP-5404-20-20	1136.25
SLS-PP-5404-24-24	2664.75
SLS-PP-5404-32-32	3908.70

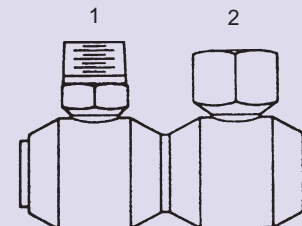

### SLS-PP-5405

(1) Male Pipe  
(2) Fem. Pipe

SLS-PP-5405-04-04	296.40
SLS-PP-5405-04-06	296.40
SLS-PP-5405-06-06	296.40
SLS-PP-5405-08-08	309.10
SLS-PP-5405-12-12	512.25
SLS-PP-5405-16-16	668.75
SLS-PP-5405-20-20	1136.25
SLS-PP-5405-24-24	2664.75
SLS-PP-5405-32-32	3908.70

# STEEL LIVE SWIVELS -PARALLEL PLANE (180° 3000 PSI)

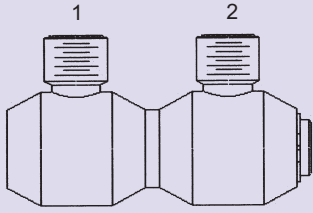

## SLS-PP-OFS-2403

- (1) Male O-Ring Face Seal
- (2) Male O-Ring Face Seal

SLS-PP-OFS-2403-04-04	348.70
SLS-PP-OFS-2403-06-04	348.70
SLS-PP-OFS-2403-06-06	348.70
SLS-PP-OFS-2403-08-04	348.70
SLS-PP-OFS-2403-08-08	348.70
SLS-PP-OFS-2403-10-08	363.60
SLS-PP-OFS-2403-10-10	363.60
SLS-PP-OFS-2403-12-12	602.60
SLS-PP-OFS-2403-16-16	786.75
SLS-PP-OFS-2403-20-20	1336.70
SLS-PP-OFS-2403-24-24	3134.95

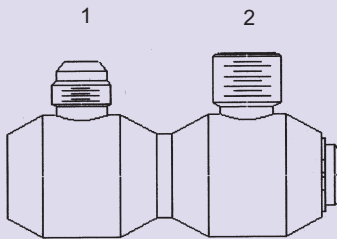

## SLS-PP-OFS-6416

- (1) Male JIC
- (2) Male O-Ring Face Seal

SLS-PP-OFS-6416-06-06	348.70
SLS-PP-OFS-6416-08-08	348.70
SLS-PP-OFS-6416-10-10	363.60
SLS-PP-OFS-6416-12-12	602.60
SLS-PP-OFS-6416-16-16	786.75
SLS-PP-OFS-6416-20-20	1336.70
SLS-PP-OFS-6416-24-24	3134.95

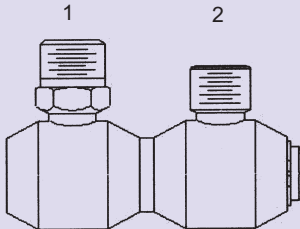

## SLS-PP-OFS-6476

- (1) Male Pipe
- (2) Male O-Ring Face Seal

SLS-PP-OFS-6476-04-06	348.70
SLS-PP-OFS-6476-06-08	348.70
SLS-PP-OFS-6476-08-10	363.60
SLS-PP-OFS-6476-12-12	602.60
SLS-PP-OFS-6476-16-16	786.75
SLS-PP-OFS-6476-20-20	1336.70
SLS-PP-OFS-6476-24-24	3134.95

Styles may vary from picture

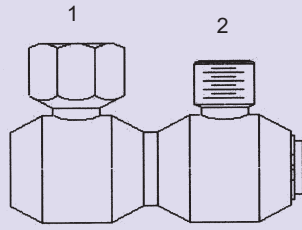

## SLS-PP-OFS-6486

- (1) Fem. Pipe
- (2) Male O-Ring Face Seal

SLS-PP-OFS-6486-04-06	348.70
SLS-PP-OFS-6486-06-08	348.70
SLS-PP-OFS-6486-08-10	363.60
SLS-PP-OFS-6486-12-12	602.60
SLS-PP-OFS-6486-16-16	786.75
SLS-PP-OFS-6486-20-20	1336.70
SLS-PP-OFS-6486-24-24	3134.95

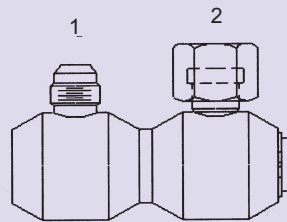

## SLS-PP-OFS-6510

- (1) Male JIC
- (2) Fem. O-Ring Face Seal

SLS-PP-OFS-6510-05-06	348.70
SLS-PP-OFS-6510-06-06	348.70
SLS-PP-OFS-6510-08-06	348.70
SLS-PP-OFS-6510-08-08	363.60
SLS-PP-OFS-6510-08-10	363.60
SLS-PP-OFS-6510-10-08	363.60
SLS-PP-OFS-6510-10-10	363.60
SLS-PP-OFS-6510-12-12	602.60
SLS-PP-OFS-6510-16-16	786.75
SLS-PP-OFS-6510-20-20	1336.70
SLS-PP-OFS-6510-24-24	3134.95

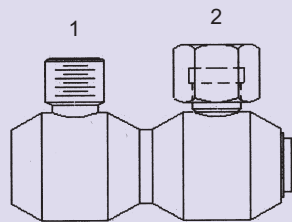

## SLS-PP-OFS-6560

- (1) Male O-Ring Face Seal
- (2) Fem. O-Ring Face Seal Swivel

SLS-PP-OFS-6560-04-06	348.70
SLS-PP-OFS-6560-06-06	348.70
SLS-PP-OFS-6560-08-06	348.70
SLS-PP-OFS-6560-08-08	363.60
SLS-PP-OFS-6560-08-10	363.60
SLS-PP-OFS-6560-10-08	363.60
SLS-PP-OFS-6560-10-10	363.60
SLS-PP-OFS-6560-12-12	602.60
SLS-PP-OFS-6560-16-16	786.75
SLS-PP-OFS-6560-20-20	1336.70
SLS-PP-OFS-6560-24-24	3134.95

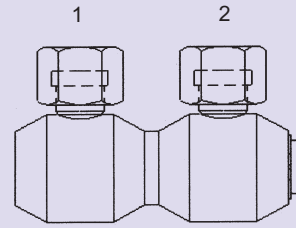

## SLS-PP-OFS-6565

- (1) Fem. O-Ring Face Seal Swivel
- (2) Fem. O-Ring Face Seal Swivel

SLS-PP-OFS-6565-06-06	348.70
SLS-PP-OFS-6565-08-08	363.60
SLS-PP-OFS-6565-10-08	363.60
SLS-PP-OFS-6565-10-10	363.60
SLS-PP-OFS-6565-12-12	602.60
SLS-PP-OFS-6565-16-16	786.75
SLS-PP-OFS-6565-20-20	1336.70
SLS-PP-OFS-6565-24-24	3134.95

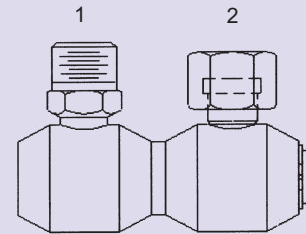

## SLS-PP-OFS-6570

- (1) Fem. O-Ring Face Seal Swivel
- (2) Male Pipe

SLS-PP-OFS-6570-04-06	348.70
SLS-PP-OFS-6570-06-06	348.70
SLS-PP-OFS-6570-08-08	363.60
SLS-PP-OFS-6570-08-10	363.60
SLS-PP-OFS-6570-12-12	602.55
SLS-PP-OFS-6570-16-16	786.75
SLS-PP-OFS-6570-20-20	1336.70
SLS-PP-OFS-6570-24-24	3134.90



**STAINLESS STEEL LIVE SWIVELS -PARALLEL PLANE- O-RING FACE SEAL**

Styles may vary from picture

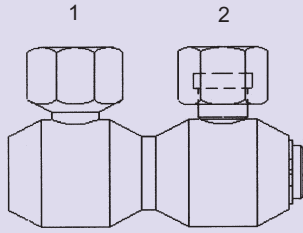

**SLS-PP-OFS-6580**

- (1) Fem. Pipe
- (2) Fem. O-Ring Face Seal Swivel

SLS-PP-OFS-6580-04-06	348.70
SLS-PP-OFS-6580-06-06	348.70
SLS-PP-OFS-6580-08-08	363.60
SLS-PP-OFS-6580-08-10	363.60
SLS-PP-OFS-6580-12-12	602.55
SLS-PP-OFS-6580-16-16	786.75
SLS-PP-OFS-6580-20-20	1336.70
SLS-PP-OFS-6580-24-24	3134.90

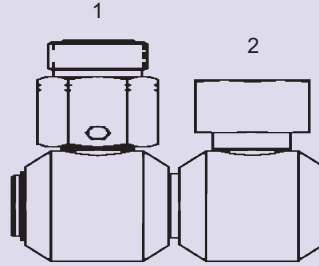

**SLS-OFS-DP-PP-6500**

- (1) Male O-Ring Face Seal
- (2) Fem. O-Ring Face Seal

SLS-OFS-DP-PP-6500-12-12	701.25
--------------------------	--------

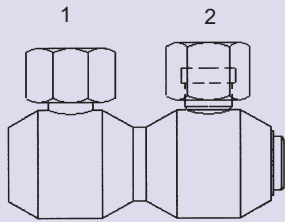

**SLS-PP-OFS-6590**

- (1) Fem. Pipe Swivel
- (2) Fem. O-Ring Face Seal Swivel

SLS-PP-OFS-6590-04-06	348.70
SLS-PP-OFS-6590-08-08	363.60
SLS-PP-OFS-6590-08-10	363.60
SLS-PP-OFS-6590-12-12	602.60
SLS-PP-OFS-6590-16-16	786.75
SLS-PP-OFS-6590-20-20	1336.70
SLS-PP-OFS-6590-24-24	3134.95

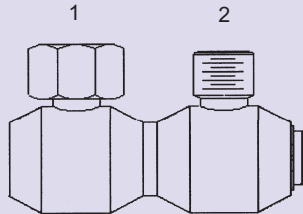

**SLS-PP-OFS-6596**

- (1) Fem. Pipe Swivel
- (2) Male O-Ring Face Seal

SLS-PP-OFS-6596-04-06	348.70
SLS-PP-OFS-6596-06-08	348.70
SLS-PP-OFS-6596-08-10	363.60
SLS-PP-OFS-6596-12-12	602.60
SLS-PP-OFS-6596-16-16	786.75
SLS-PP-OFS-6596-20-20	1336.70
SLS-PP-OFS-6596-24-24	3134.95

# STAINLESS STEEL LIVE SWIVELS

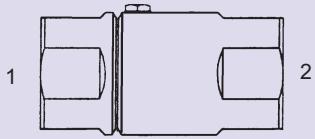

**SS-LS-5000**

- (1) Fem. Pipe - Stem
- (2) Fem. Pipe - Barrel

SS-LS-5000-04-04	585.75
SS-LS-5000-06-06	606.00
SS-LS-5000-08-08	641.40
SS-LS-5000-12-12	803.55
SS-LS-5000-16-16	1093.85
SS-LS-5000-20-20	1403.00
SS-LS-5000-24-24	3305.85
SS-LS-5000-32-32	4209.60

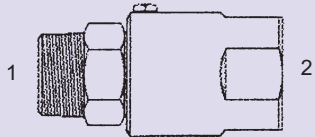

**SS-LS-5405**

- (1) Male Pipe - Stem
- (2) Fem. Pipe - Barrel

SS-LS-5405-04-04	585.75
SS-LS-5405-06-06	606.00
SS-LS-5405-08-08	641.30
SS-LS-5405-12-12	803.55
SS-LS-5405-16-16	1129.25

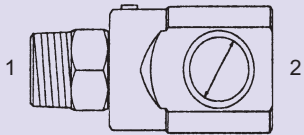

**SS-LS-5502-SB - 90°**

- (1) Male Pipe - Stem
- (2) Fem. Pipe - Barrel
- (Short Body)

SS-LS-5502-SB-04-04	648.55
SS-LS-5502-SB-06-06	657.55
SS-LS-5502-SB-08-08	657.55
SS-LS-5502-SB-12-12	926.30
SS-LS-5502-SB-16-16	1150.85

Styles may vary from picture

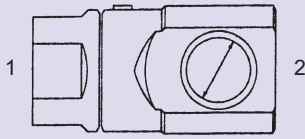

**SS-LS-5504-SB - 90°**

- (1) Male Pipe - Stem
- (2) Fem. Pipe - Barrel
- (Short Body)

SS-LS-5504-SB-04-04	648.55
SS-LS-5504-SB-06-06	657.55
SS-LS-5504-SB-08-08	657.55
SS-LS-5504-SB-12-12	926.30
SS-LS-5504-SB-16-16	1150.85
SS-LS-5504-SB-20-20	1415.85
SS-LS-5504-SB-24-24	3305.85
SS-LS-5504-SB-32-32	4326.90

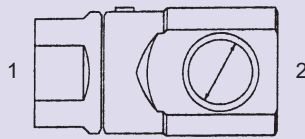

**SS-LS-5504-SB-HP - 90°**

High Pressure

- (1) Male Pipe - Stem
- (2) Fem. Pipe - Barrel
- (Short Body)

SS-LS-5504-SB-HP-12-12	926.40
------------------------	--------

# PARTS INDEX

SLS-1501	1	SLS-6841-4K-O	8	SLS-OFS-6580	17
SLS-1501-4K	1	SLS-6841-5K-O	9	SLS-OFS-6816	17
SLS-1501-5K	1	SLS-6841-LH-O	9	SLS-OFS-6816-4K	17
SLS-1502	1	SLS-6843-O	9	SLS-OFS-6816-5K	17
SLS-1502-4K	1	SLS-6843-4K-O	9	SLS-OFS-6840-O	18
SLS-1502-5K	1	SLS-6845-O	9	SLS-OFS-6840-5K-O	18
SLS-1704-61	1	SLS-6845-SB-O	9	SLS-OFS-6846-O	18
SLS-1704-62	1	SLS-6849-O	9	SLS-OFS-6846-4K-O	18
SLS-2403	1	SLS-6901-O	9	SLS-OFS-6846-5K-O	18
SLS-2405	2	SLS-6975-SB	9	SLS-OFS-6846-LH-O	18
SLS-2412	2	SLS-6985-SB	9	SLS-OFS-6861	18
SLS-2421	2	SLS-DP-2500	10	SLS-OFS-6861-5K	19
SLS-2471	2	SLS-DP-2500-4K	10	SLS-OFS-6866	19
SLS-2472	2	SLS-DP-2500-5K	10	SLS-OFS-6866-4K	19
SLS-2481	2	SLS-DP-2502	10	SLS-OFS-6866-5K	19
SLS-2500	2	SLS-DP-2571	10	SLS-OFS-6876	19
SLS-2500-4K	2	SLS-DP-2571-4K	10	SLS-OFS-6876-4K	19
SLS-2500-5K	2	SLS-DP-2571-5K	10	SLS-OFS-6876-5K	19
SLS-2500-LH	3	SLS-DP-2581	11	SLS-OFS-6876-5K-LH	20
SLS-2501	3	SLS-DP-5502	11	SLS-OFS-6876-LH	20
SLS-2502	3	SLS-DP-5502-4K	11	SLS-OFS-6886	20
SLS-2502-SB	3	SLS-DP-5502-5K	11	SLS-OFS-6886-4K	20
SLS-2519	3	SLS-DP-5504	11	SLS-OFS-6886-5K	20
SLS-2571	3	SLS-DP-5504-4K	11	SLS-OFS-DP-PP-6500	23
SLS-2571-4K	4	SLS-DP-5504-5K	11	SLS-PP-1404	21
SLS-2571-5K	4	SLS-DP-6805-O	11	SLS-PP-1406	21
SLS-2573	4	SLS-DP-6841-O	12	SLS-PP-2403	21
SLS-2573-4K	4	SLS-DP-6841-4K-O	12	SLS-PP-2404	21
SLS-2573-5K	4	SLS-DP-6841-5K-O	12	SLS-PP-2405	21
SLS-2581	4	SLS-DP-OFS-6816	12	SLS-PP-2800	21
SLS-2581-4K	4	SLS-DP-OFS-6846-O	12	SLS-PP-5000	21
SLS-2583	4	SLS-DP-OFS-6846-4K	12	SLS-PP-5404	21
SLS-2583-4K	5	SLS-DP-OFS-6846-5K	12	SLS-PP-5405	21
SLS-2710	5	SLS-DP-OFS-6861	12	SLS-PP-OFS-2403	22
SLS-2711	5	SLS-DP-OFS-6866	13	SLS-PP-OFS-6416	22
SLS-2712	5	SLS-DP-OFS-6866-4K	13	SLS-PP-OFS-6476	22
SLS-2715-SB	5	SLS-DP-OFS-6866-5K	13	SLS-PP-OFS-6486	22
SLS-2717	5	SLS-DP-OFS-6868	13	SLS-PP-OFS-6510	22
SLS-2718-SB	5	SLS-DP-OFS-6876	13	SLS-PP-OFS-6560	22
SLS-2719	5	SLS-DP-OFS-6886	13	SLS-PP-OFS-6565	22
SLS-5000	5	SLS-OFS-2406	14	SLS-PP-OFS-6570	22
SLS-5000-HP	6	SLS-OFS-2507	14	SLS-PP-OFS-6580	23
SLS-5405	6	SLS-OFS-2509	14	SLS-PP-OFS-6590	23
SLS-5405-HP	6	SLS-OFS-2510	14	SLS-PP-OFS-6596	23
SLS-5500	6	SLS-OFS-2510-5K	14	SS-LS-5000	24
SLS-5502	6	SLS-OFS-2567	14	SS-LS-5405	24
SLS-5502-SB	6	SLS-OFS-2700-LN	15	SS-LS-5502-SB	24
SLS-5502-SB-HP	6	SLS-OFS-2701-LN-4K	15	SS-LS-5504-SB	24
SLS-5504	6	SLS-OFS-2701-LN-5K	15	SS-LS-5504-SB-HP	24
SLS-5504-SB	6	SLS-OFS-2716-LN-4K	15		
SLS-5504-SB-HP	7	SLS-OFS-2716-LN-5K	15		
SLS-5587	7	SLS-OFS-6426	15		
SLS-6402-O	7	SLS-OFS-6446-O	15		
SLS-6441-O	7	SLS-OFS-6461	15		
SLS-6448-O	7	SLS-OFS-6466	16		
SLS-6455	7	SLS-OFS-6468	16		
SLS-6513	7	SLS-OFS-6476	16		
SLS-6513-4K	7	SLS-OFS-6500	16		
SLS-6573	7	SLS-OFS-6500-5K	16		
SLS-6573-4K	8	SLS-OFS-6510	16		
SLS-6805-O	8	SLS-OFS-6510-5K	16		
SLS-6805-SB-O	8	SLS-OFS-6560	16		
SLS-6806-O	8	SLS-OFS-6560-4K	17		
SLS-6814-4K-O	8	SLS-OFS-6560-5K	17		
SLS-6814-5K-O	8	SLS-OFS-6565	17		
SLS-6815-SB	8	SLS-OFS-6565-5K	17		
SLS-6841-O	8	SLS-OFS-6570	17		



---

**FITTINGS UNLIMITED, INC.**

---

*Adapter & Fitting Specialist*

**1-800-348-8467**